

# **SOLAR AND ENERGY STORAGE SYSTEM**

**PERMITTING &  
INSPECTION GUIDELINES**

**FOR PERMITTING AND INSPECTING  
ENERGY STORAGE OR COMBINED SOLAR  
AND ENERGY STORAGE SYSTEMS IN SINGLE  
FAMILY & DUPLEX HOMES**

**2020 NATIONAL ELECTRICAL CODE (NEC),  
2021 INTERNATIONAL RESIDENTIAL CODE (IRC)  
AND 2021 INTERNATIONAL FIRE CODE (IFC)**

# TABLE OF CONTENTS

Acknowledgements .....	<a href="#">2</a>
Introduction .....	<a href="#">3</a>
Permit Submission Requirements.....	<a href="#">6</a>
General Installation Guide .....	<a href="#">7</a>
Energy Storage System Requirements.....	<a href="#">7</a>
Energy Storage System Installation Requirements .....	<a href="#">7</a>
Energy Storage System Size and Location Requirements .....	<a href="#">8</a>
Photovoltaic and Energy Storage System Interconnection Requirements...	<a href="#">10</a>
PV System Electrical Code Installation Requirements.....	<a href="#">11</a>
Structural PV Array Mounting and Installation Location Requirements .....	<a href="#">12</a>
Plan Review Checklist .....	<a href="#">13</a>
Field Inspection Checklist.....	<a href="#">15</a>
Supporting Resources .....	<a href="#">17</a>
Appendix A: Solar and/or ESS Permit Application .....	<a href="#">18</a>
Appendix B: Solar and Energy Storage Standard Electrical Line Diagrams .....	<a href="#">20</a>

## ACKNOWLEDGMENTS

This permitting and inspection guide was developed in collaboration between New Buildings Institute, Earth Advantage, and several expert reviewers, including Pete Jackson, Electrical Specialist, City of Bakersfield, Keith Winston, Code Official and Solar Coordinator, Department of Community and Regulatory Affairs, Washington, DC, Bryan Holland, Senior Technical Field Representative, National Electrical Manufacturer’s Association, and Tesla.



## ACKNOWLEDGMENT AND DISCLAIMER

This material is based upon work the supported by the Department of Energy and Office of Energy Efficiency and Renewable Energy (EERE), under Award Number EE0009457.

This report was prepared as an account of work sponsored by an agency of the United States Government. Neither the United States Government nor any agency thereof, nor any of their employees, makes any warranty, express or implied, or assumes any legal liability or responsibility for the accuracy, completeness, or usefulness of any information, apparatus, product, or process disclosed, or represents that its use would not infringe privately owned rights. Reference herein to any specific commercial product, process, or service by trade name, trademark, manufacturer, or otherwise does not necessarily constitute or imply its endorsement, recommendation, or favoring by the United States Government or any agency thereof. The views and opinions of authors expressed herein do not necessarily state or reflect those of the United States Government or any agency thereof.

The solar and energy storage criteria in this guideline is based on SolSmart’s National Simplified Residential PV and Energy Storage Permit and Inspection Guidelines. For more information about SolSmart, a program intended to provide no-cost technical assistance to jurisdictions who want to make it faster, easier and more affordable for their communities to go solar visit: [www.solsmart.org](http://www.solsmart.org). The SolSmart guide is supported by the Department of Energy and Office of Energy Efficiency and Renewable Energy (EERE), under Award Number DEEE0007155.

Use of Solar and Energy Storage System Permitting and Inspection Guidelines is permitted on a royalty-free basis. The authors claim no rights in and make no representations as to the contents or use of the 2020 National Electrical Code (NEC), the 2021 International Residential Code (IRC) and the 2021 International Fire Code (IFC). The authors further make no representations as to the suitability of this guide for any purpose, and all content is provided as-is. Projects are expected to meet locally adopted codes and should refer to the 2020 NEC, 2021 IRC and 2021 IFC and local amendments to ensure full compliance.

# INTRODUCTION

More and more, buildings are incorporating energy storage systems with photovoltaic systems to both provide a backup power source to a building and reduce utility bills. This is a new aspect of building operations that a growing number of jurisdictions will need to address. This guide provides an overview of code requirements for the installation of energy storage systems (ESS) and combined solar and energy storage system installations. By providing a specific and replicable list of permitting and inspection requirements, local jurisdictions can reduce informational barriers and help ensure the design and installation of solar and energy storage are consistent and code-compliant. This guide references the most applicable requirements for the 2020 National Electrical Code (NEC), the 2021 International Residential Code (IRC), and the 2021 International Fire Code (IFC). Not all requirements are covered by these checklists, but they do include the most important life and safety aspects of the installation and can be used to highlight “common mistakes” made by installers. While these guidelines are geared primarily toward implementing the 2020 NEC, 2021 IRC, and 2021 IFC, jurisdictions enforcing and contractors using earlier editions of these codes can make use of these guidelines which include code requirements that increase safety and reliability.

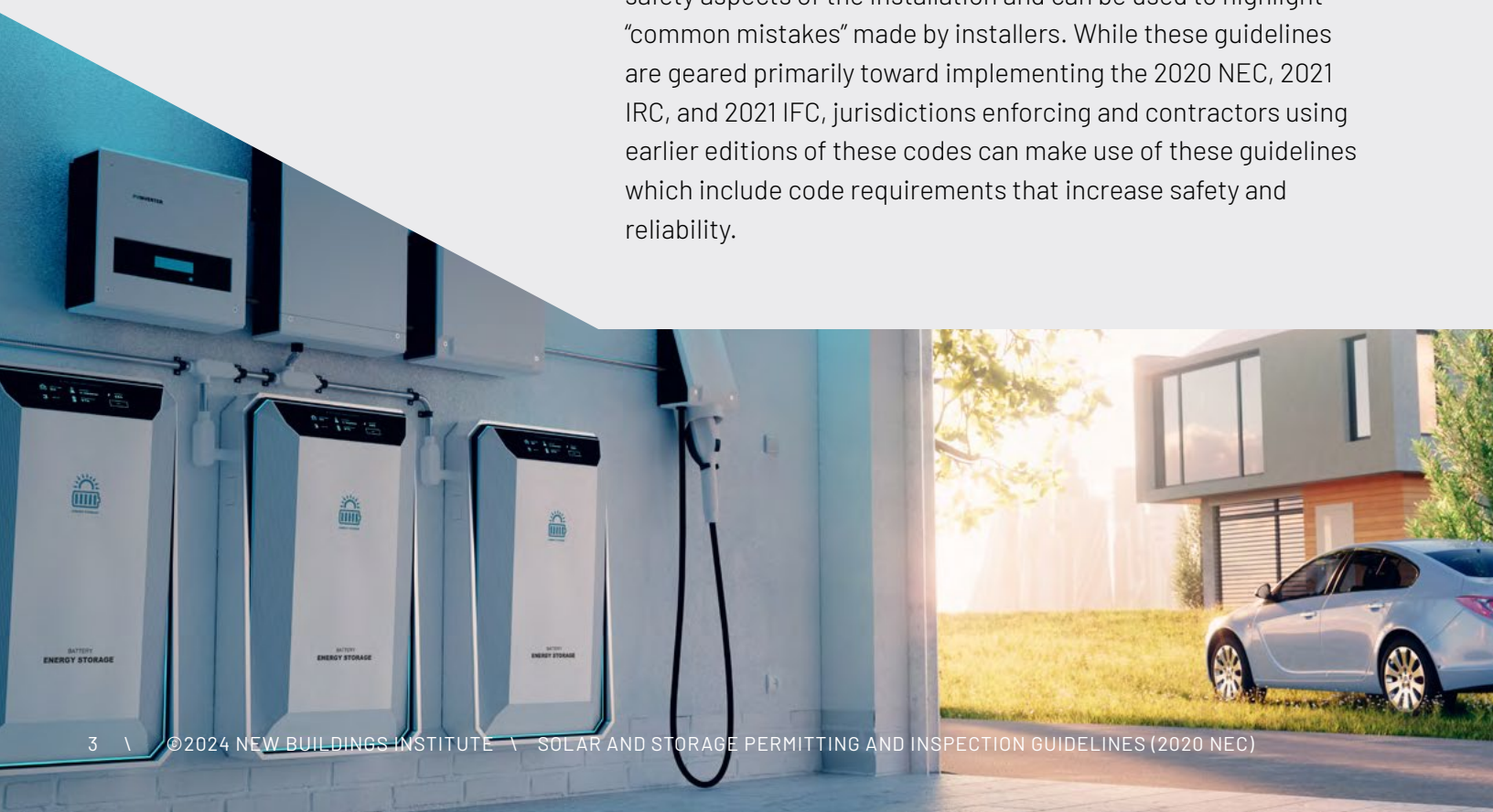

# HOW TO USE THIS GUIDE

Read this guide for an overview of code requirements for the installation of energy storage systems (ESS) and combined solar and energy storage system installations. The process described in this guide can be adopted as-is, used as a reference, or adapted to incorporate specific local requirements. Designers, contractors, and building owners can use this guide to gain an understanding of what to expect in the permitting and inspection processes.

Jurisdictions and building departments can use this guide as a starting point for conducting a plan review and inspection for solar and energy storage installations. When adopting or adapting this guide, departments and their permit applicants are advised to reference all applicable local codes and requirements, including different cycles of the referenced codes as needed.

The replicable lists of permitting and inspection requirements in this guide can be used to reduce informational barriers and help ensure the design and installation are consistent and code-compliant. Any department implementing a new permitting and inspection process based on this guide is advised to provide communication, coordination, and education to key stakeholders in order to support successful implementation, including, but not limited to, the following:

- Communicate intentions with the utility company.
- Inform the Fire Department of any changes.
- Provide training to plan reviewers.

## **This guide has limitations on its intended use, including the following:**

✘ This solar and storage permitting and inspection guide does not include requirements for any service upgrades or other electrical work. If the required load calculation demonstrates a service upgrade is needed, this streamlined permitting and inspection guide cannot be used to determine code compliance of the service upgrade.

✘ The electrical requirements in this guide primarily focus on the requirements in Article 625: Electric Vehicle Power Transfer System of the National Electrical Code.

✘ This solar and storage permitting and inspection guide does not include requirements for indoor installation of infrastructure for EV batteries that require additional ventilation, including flooded lead-acid or nickel-iron batteries.

✘ Where electrical service or metering upgrades are required, another permit may be required before this guide can be followed.

## **Additional general electrical requirements detailed in chapters one through four of the National Electrical Code also apply but are not listed throughout this guide. These include, but are not limited to, the following:**

- Electrical equipment is installed in a neat and workmanlike manner. (NEC 110.12)
- Electrical connections of the circuit conductors and equipment grounding conductor connections are secure. (NEC 110.14. 250.148(A))
- Installed branch circuit wiring is properly secured, supported, and routed to prevent physical damage. (NEC 300.11)

# PERMIT APPROVAL REQUIREMENTS

- ☑ This permitting and inspection guide is only applicable to the installation of the following applications:
  - Lithium-ion energy storage systems
  - Energy storage systems with total maximum energy capacity on site of 600kWh
  - Energy storage systems installed with simple solar systems meeting SolSmart criteria that are less than 15kW consisting of no more than 2 series strings per inverter and no more than 4 source circuits in total per inverter.
- ☑ Standard electrical diagrams are provided in Appendix B and can be used to accurately represent the ESS or combined ESS and PV installations. If the electrical system is more complex than the standard electrical diagram can effectively communicate, the project does not meet the requirements for a simplified permit application and additional information may be necessary for the jurisdiction to process the permit application.
- ☑ This permitting and inspection guide does not include any service upgrades or other electrical work. If the load calculations demonstrate a service upgrade is needed, this permitting and inspection guide cannot be used to determine compliance with code requirements for a service upgrade.

"National Simplified Residential PV and Energy Storage Permit Guidelines." SolSmart, <https://solsmart.org/resources/national-simplified-residential-pv-and-energy-storage-permit-guidelines/>



# PERMIT SUBMISSION REQUIREMENTS

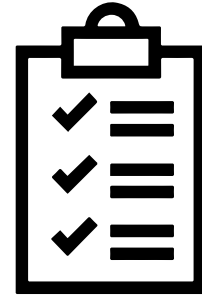

## TO APPLY FOR A PERMIT, SUBMIT THE FOLLOWING:

**1) Permit application**<sup>1</sup> (see Appendix A), which includes basic information about the project, location, and installer.

**2) Site plan (see Appendix B) drawn to scale showing:**

- a) Location of PV array and ESS components on the property
- b) Primary use of the space or area where the ESS will be installed
- c) ESS spacing
- d) PV and ESS setback and access pathways
- e) Fire detection, and fire suppression systems if applicable
- f) Mounting details (quantity and location of structural attachments and flashing method)

**3) A standard electrical line diagram (see Appendix B) that accurately indicates:**

- a) PV array configuration (if applicable)
- b) ESS components
- c) Conductors, cables, and conduit types, sizes, and markings
- d) Type and size rating of overcurrent protection and disconnects
- e) Inverters
- f) Required signs
- g) Connection to the premises wiring system, and
- h) Location of additional meters, main electrical service panel, distribution panels or subpanels

**4) Specification sheets and installation manuals for all major system components including: ESS and PV components, inverters, mounting systems, PV modules, and DC-to-DC converters.**

**5) Documentation showing that ESS meets utility interconnection requirements.**

---

<sup>1</sup> Jurisdiction can fill this text box with link to their own permit application. A sample permit application is shown as Appendix A to this guide.

# GENERAL INSTALLATION GUIDE

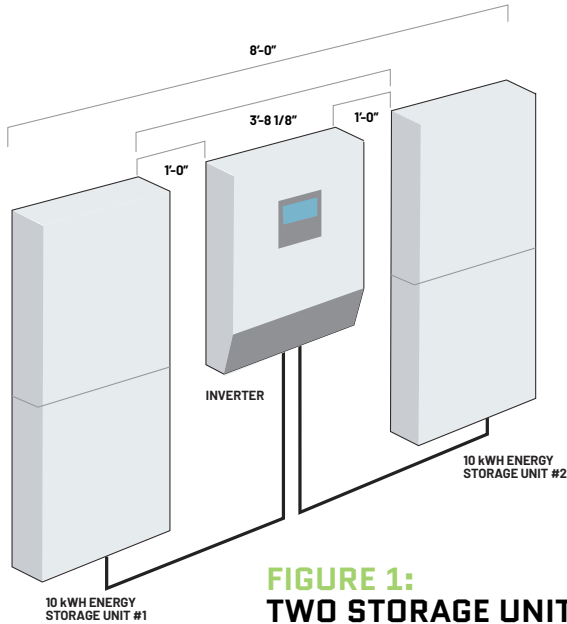

**FIGURE 1:  
TWO STORAGE UNITS  
COMPLYING WITH 3  
FOOT SEPARATION**

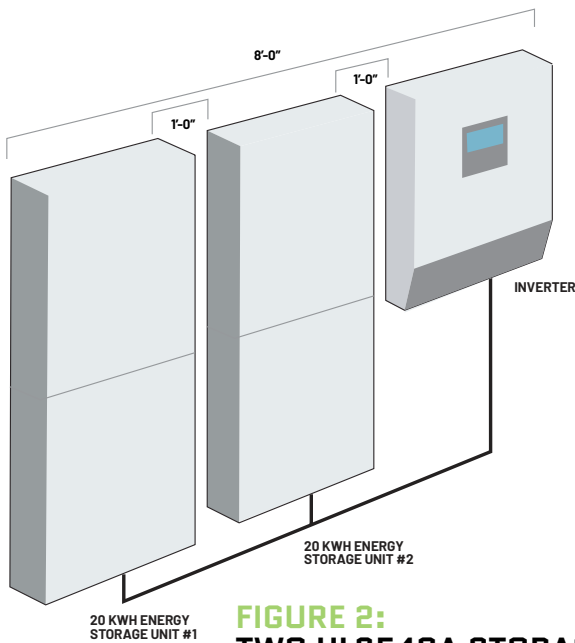

**FIGURE 2:  
TWO UL9540A STORAGE  
UNITS COMPLYING  
WITH MANUFACTURER  
INSTRUCTIONS**



## ENERGY STORAGE SYSTEM REQUIREMENTS

- 1 ESS is listed to UL9540 or UL9540a by a Nationally Recognized Testing Laboratory (NRTL). (IFC 1207.3)
- 2 ESS is listed to UL1973. (NEC 706.5)
- 3 Inverters are certified to UL1741. (NEC 690.4(B))



## ENERGY STORAGE SYSTEM INSTALLATION REQUIREMENTS

- 4 ESS is installed according to manufacturer installation instructions. (NEC 110.3(B))
- 5 All work is done in a neat and workmanlike manner. (NEC 110.12)
- 6 Access and working space for ESS equipment such as ESS units, battery units, inverters, disconnecting means, and panelboards is adequate. Working space is at least 30 inches in width, 6.5 feet in height, and 4 feet in depth or the width, height, and depth of the equipment, whichever is greater. (NEC 110.26)
- 7 Grounding/bonding of ESS units, battery units, inverters, conduit and other electrical equipment according to the NEC and manufacturer's instructions. (NEC 110.14, 250.148(A), NEC 110.3(B))
- 8 The individual ESS units are no larger than 20kWh. (IRC R328.5)
- 9 ESS units that are UL9540 certified are separated by 3 feet. (IRC R328.3.1, IFC1207.5.1)
- 10 Energy Storage Systems that have undergone large-scale fire testing to UL9540a may be spaced less than 3 feet apart if fire testing is accepted by the authority having jurisdiction. (IRC R328.3.1, IFC1207.5.1, NEC 110.3(B))

### FIGURE 3: LARGE SCALE FIRE TESTED LABEL



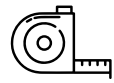

## ENERGY STORAGE SYSTEM SIZE LOCATION REQUIREMENTS

- 11** Each ESS unit meets one of the size and location limitations shown below: (IRC R328.4, IRC R328.5)
  - a) 80 kWh in attached garages separated from the dwelling unit living space with ½" gypsum board between garages and residence or attics and 5/8" Type X gypsum between garage and habitable room above garage. If sheetrock rating of homes built under a code older than the 2009 IRC cannot be verified, sheetrock is installed to meet this requirement (IRC R302.6)
  - b) 80 kWh on exterior walls a minimum 3 feet (914 mm) from doors and windows directly entering the dwelling unit. There is no restriction on how close an ESS unit can be to windows or doors entering a garage because the garage is not considered part of the dwelling unit
  - c) 40 kWh within utility closets, basements, and storage or utility spaces with finished or noncombustible walls and ceilings. Walls and ceilings of unfinished wood-framed construction shall be provided with minimum 5/8" Type X gypsum
  - d) 80 kWh in detached garages and detached accessory structures
  - e) 80 kWh outdoors on the ground a minimum 3 feet from doors and windows directly entering the dwelling unit. There is no restriction on how close an ESS unit can be to windows or doors entering a garage because the garage is not considered part of the dwelling unit
- 12** ESS is protected from vehicular impact by one of the following: (IRC 328.8, IFC 1207.4.5)
  - a) Installed in a location not subject to vehicular impact such as on a side wall or 4' above floor level or
  - b) Guard posts located 6 inches or more away from the ESS
  - c) Wheel barriers anchored in place located 4.5 feet or more away from the ESS
  - d) Other barriers where approved
- 13** Smoke alarms are installed in dwelling units and basements in which ESS is installed. (IRC R328.7, IRC R314)
- 14** For ESS installed in unconditioned indoor spaces such as dwelling units and attached garages that can exceed the temperature limits of smoke alarms (32°F-100°F), heat alarms are installed. (IRC R328.7)



The following figure illustrates the effect that the location limitations have on an ESS on the outside wall of a residence or on the inside wall of an attached garage. The green highlighted area depicts zones that meet the location limitations for outside walls in this guideline

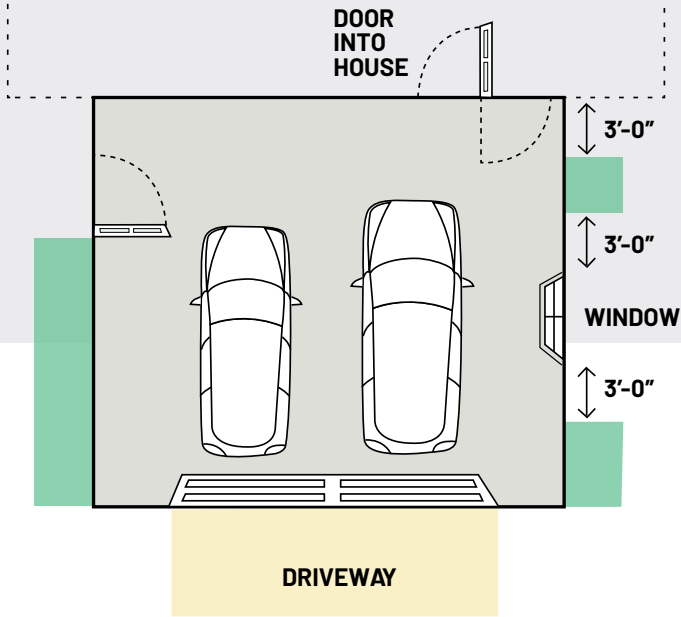

**FIGURE 4:**  
ESS MOUNTING  
OPTIONS ON HOUSE AND  
ATTACHED GARAGE EXTERIOR

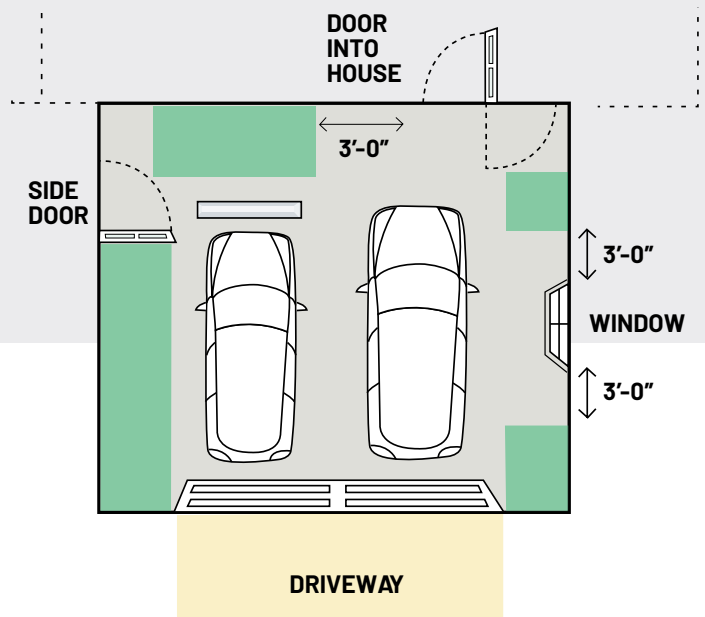

**FIGURE 5:**  
ESS MOUNTING  
OPTIONS INSIDE ATTACHED  
GARAGE

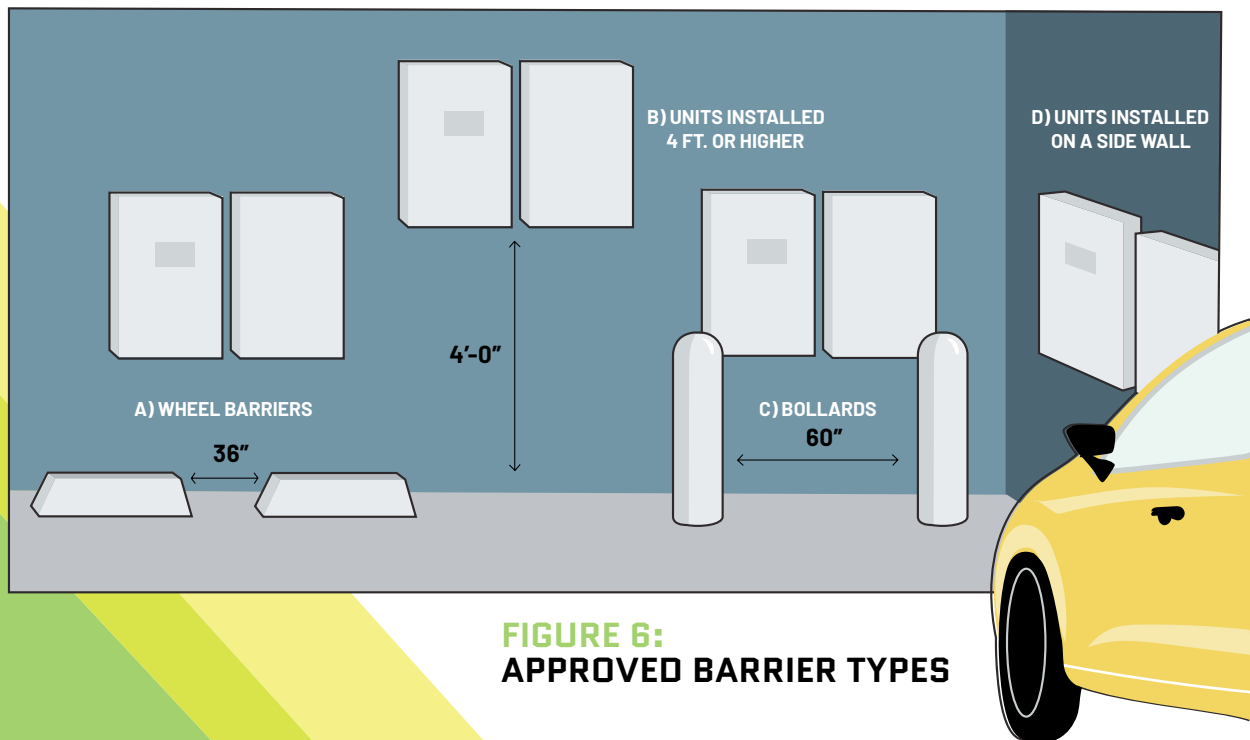

**FIGURE 6:**  
APPROVED BARRIER TYPES



## PHOTOVOLTAIC AND ENERGY STORAGE SYSTEM INTERCONNECTION REQUIREMENTS

- 15** The inverter installation meets the requirements of one of the items below: (NEC 705)
- A) Supply-side connection complies with the following: (NEC 705.11)
    - a) The sum of the power source continuous current output rating on a service does not exceed the capacity of the service conductors (NEC 705.11 (A))
    - b) The power source output circuit conductors to the first OCPD device are no smaller than 6AWG copper and sized at 125% of maximum current or maximum current with adjustment and correction factors (NEC 705.11 (B), 705.28)
    - c) Power source output circuit conductors are protected by an OCPD (NEC 705.11 (C), 705.30)
    - d) When power source output circuit conductors make a connection to service outside the building, OCPD are located in a readily accessible location outside the building or where the power source conductors enter the building (NEC 705.11 (C))
    - e) When power source output circuit conductors make their connection to the service inside a building, OCPD are either within 10 feet of conductor length in dwelling units and 16.5 feet in other than dwelling units from the point of connection to the service or located within 71 feet of conductor length from the point of connection to service (NEC 705.11 (C))
  - B) Load-side connection complies with the following:
    - a) Each source interconnection is made at a dedicated circuit breaker or fusible disconnecting means (NEC 705.12 (A))
    - b) The bus amp meets the 120% busbar rating
  - C) Load-side Power Control Systems that use controls to prevent overcurrent of equipment are listed to UL1741 CRD and shall comply with the following:
    - a) Each source interconnection is made at a dedicated circuit breaker or fusible disconnecting means (NEC 705.12 (A))
    - b) The bus amp meets the 120% busbar rating allowance in a building. Table 1: AC Interconnection Options below displays several AC Interconnection options (NEC 705.12 (B))
    - c) Equipment containing OCPD is marked to indicate the presence of all sources (NEC 705.12 (C))
    - d) Fused disconnects are suitable for backfeed. Circuit breakers must either not be marked "line" or "load" or be specifically rated for backfeed (NEC 705.12 (D))
    - e) Circuit breakers backfed from power sources that are interactive do not need a fastener (NEC 705.12 (E))
  - D) Load-side distribution equipment listed to combine sources and supply loads

Maximum Inverter Current	Required Inverter OCPD Size *	Minimum Conductor Size (Copper) in Conduit	Minimum Busbar/ Main Breaker Combinations Busbar Amps/Main Amps
64 Amps	80 Amps	4 AWG	400/400; 200/150
56 Amps	70 Amps	4 AWG	225/200; 250/225
48 Amps	60 Amps	6 AWG	300/300; 200/175
40 Amps	50 Amps	8 AWG	125/100; 150/125
32 Amps	40 Amps	8 AWG	225/225; 200/200; 150/125
24 Amps	30 Amps	10 AWG	150/150
16 Amps	20 Amps	12 AWG	100/100; 70, 60**
12 Amps	15 Amps	12 AWG	80/80**

**TABLE 1:**  
**AC INTERCONNECTION OPTIONS**

\* Overcurrent Protection Device (OCPD)  
\*\* Minimum service rating is 100A for a one- or two-family dwelling



## PV SYSTEM ELECTRICAL CODE INSTALLATION REQUIREMENTS

- 16** All work done in a neat and workmanlike manner. (NEC 110.12)
- 17** Access and working space is provided for PV equipment such as inverters, disconnecting means, and panelboards (not required for PV modules). (NEC 110.26)
- 18** Exposed cables are properly secured, supported, and routed to prevent physical damage.
- 19** Grounding/bonding of rack, modules, inverter(s), and other electrical equipment according to the manufacturer's instructions. (NEC 110.3(B))
- 20** PV system markings, labels, and signs according to the NEC. (NEC 690.13(B), 690.53, 690.54, 690.56)
- 21** Major electrical components including PV modules, DC-to-DC converters, and inverters are identified for use in PV systems.
- 22** Inverters are listed as utility-interactive in accordance with UL 1741.
- | Grid Support Utility Interactive Non Isolated Photovoltaic Inverter |  |
|---|--|
| Operating Voltage Range   | 270 – 480Vdc   |
| Max Input Current   | 10.5A <sub>dc</sub>  |
| Max Continuous Output Power   | 3300Wac @ 208V 3800Wac @ 240V                                    |
| Voltage Min – Nom – Max   | 183 – 208 – 229V <sub>ac</sub><br>211 – 240 – 264V <sub>ac</sub> |
- 23** PV panel systems and array mounting system are listed and identified with a fire classification in accordance with UL 2703. (NEC 690.43(A))
- 
- 24** PV Modules are listed as UL 1703, UL 61730-1, or UL 61730-2. (NEC 690.4(B))
- 25** The PV array consists of no more than 2 series strings per inverter input and no more than 4 source circuits strings in total per inverter.
- 26** The maximum PV DC system voltage for a single-family home or duplex is limited to 600Vdc. Use either the checklist shown below or methods described in 690.7(A)(1) or 690.7(A)(3) to ensure the system is designed and connected so that 600Vdc is not exceeded on the average coldest day of the year. (NEC 690.7)
- ASHRAE Extreme Annual Mean Minimum Design Dry Bulb Temperature (one source is <https://energyresearch.ucf.edu/solar-certification/solar-reference-map/>); Table 690.7(A)(NEC) value \_\_\_\_\_
  - Max module Voc (adjusted at minimum temperature): Rated Voc \_\_\_\_\_V x Table 690.7(A) value= \_\_\_\_\_V
  - DC-to-DC converter(s) or microinverter rated maximum input voltage: \_\_\_\_\_V (must be greater than Max module Voc in (b.))
  - Maximum number of DC-to-DC converters allowed in series (up to 600Vdc): \_\_\_\_\_
  - Maximum number of DC-to-DC converters allowed in series (up to 600Vdc): \_\_\_\_\_
  - Inverter(s) rated maximum input voltage: \_\_\_\_\_V (must be greater than g. below)
  - Inverter input max V: Max module Voc (b.) \_\_\_\_\_V x max # in series= \_\_\_\_\_V
- 27** PV system circuits on buildings meet requirements for controlled conductors.
- Controlled conductors more than one foot from the array are capable of being shutdown to below 30 volts within 30 seconds
  - PV array wiring within the array are either listed to the PV Hazard Control product safety standard (UL3741) or limited to not more than 80 volts within 30 seconds of rapid shutdown initiation. (NEC 690.12)
- 28** The PV System disconnecting means is sized for the maximum short circuit current and voltage and installed in a readily accessible location. (NEC 690.13(A))

**FIGURE 7:**  
UTILITY  
INTERACTIVE  
INVERTER  
LISTING

**FIGURE 8:**  
UL2703  
LISTED  
GROUNDING  
DEVICE



## STRUCTURAL PV ARRAY MOUNTING AND INSTALLATION LOCATION REQUIREMENTS

- 29** PV arrays are located to meet the IRC fire setback and access pathway requirements.
- At least two pathways not less than 3 feet wide are provided on separate roof planes from the lowest roof edge to ridge.
  - At least one pathway is on the street or driveway side of the roof. PV arrays occupying less than 1/3 of the roof area are set back 1.5 feet on both sides of the horizontal ridge.
  - PV arrays occupying more than 1/3 of the roof area have a 3 foot setback on both sides of a horizontal ridge. (IRC 324.6)

**FIGURE 9:**  
**SITE PLAN WITH FIRE SETBACK AND ACCESS PATHWAY REQUIREMENTS DETAILED**

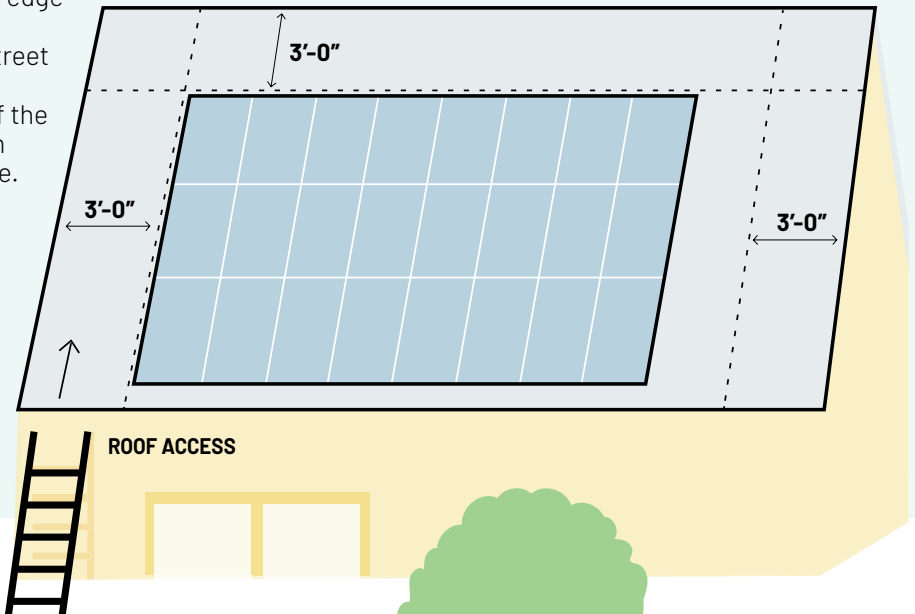

- 30** The weight of the PV system is 4 lbs/square foot or less.
- 31** The attachment points of the mounting system are either staggered or installed in a low snow load (10 psf or less) and low wind load (120 mph or less) location.
- 32** Roof penetrations flashed/sealed according to the approved plan and manufacturers' instructions. (NEC 110.3(B))
- 33** The maximum spacing in inches between adjacent attachment points of the mounting system is either 2 feet or less or no larger than 6 feet in a low snow load (10 psf or less) and low wind load (120 mph or less) location.
- 34** The PV array is flush mounted (parallel to roof) or the maximum distance off the roof is between 2 inches and 10 inches.
- 35** The individual roof structure appears to be structurally sound, without signs of alterations or significant structural deterioration or sagging. There are no visually apparent disallowed rafter holes, notches or truss modifications, no visually apparent structural decay or unrepaired fire damage. Roof sag, measured in inches is not more than the rafter or ridge beam length in feet divided by 20.
- 36** Standing seam metal roofs are limited to a design snow load of no greater than 15 psf.



# PLAN REVIEW CHECKLIST



## ENERGY STORAGE SYSTEM REQUIREMENTS

- 1** ESS is listed to UL9540 by a Nationally Recognized Testing Laboratory (NRTL).
- 2** Inverters are certified to UL1741.



## ENERGY STORAGE SYSTEM INSTALLATION REQUIREMENTS

- 3** The individual ESS units are no larger than 20kWh.
- 4** ESS units that are UL9540 certified are separated by 3 feet.
- 5** Energy Storage Systems that have undergone large-scale fire testing to UL9540a may be spaced fewer than 3 feet apart if fire testing is approved by the authority having jurisdiction.

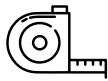

## ENERGY STORAGE SYSTEM SIZE AND LOCATION REQUIREMENTS

- 6** Each ESS unit meets one of the size and location limitations shown below: (IRC R328.4, IRC R328.5)
  - a) 80 kWh in attached garages separated from the dwelling unit living space with 1/2" gypsum board between garages and residence or attics and 5/8" Type X gypsum between garage and habitable room above garage. If sheetrock rating of homes built under a code older than the 2009 IRC cannot be verified, sheetrock is installed to meet this requirement
  - b) 80 kWh on exterior walls a minimum 3 feet (914 mm) from doors and windows directly entering the dwelling unit. There is no restriction on how close an ESS unit can be to windows or doors entering a garage because the garage is not considered part of the dwelling unit
  - c) 40 kWh within utility closets, basements, and storage or utility spaces with finished or noncombustible walls and ceilings. Walls and ceilings of unfinished wood-framed construction shall be provided with minimum 5/8" Type X gypsum
  - d) 80 kWh in detached garages and detached accessory structures
  - e) 80 kWh outdoors on the ground a minimum 3 feet from doors and windows directly entering the dwelling unit. There is no restriction on how close an
- 7** ESS unit can be to windows or doors entering a garage because the garage is not considered part of the dwelling unit. ESS is protected from vehicular impact by one of the following:
  - a) Installed in a location not subject to vehicular impact such as on a side wall or 4' above floor level, or
  - b) Protected by guard posts located 6 inches or more away from the ESS.
  - c) Protected by wheel barriers anchored in place located 4.5 feet or more away from the ESS.
  - d) Protected by other barriers where approved
- 8** Smoke alarms are installed in dwelling units and basements in which ESS is installed.
- 9** For ESS installed in unconditioned indoor spaces such as dwelling units and attached garages that can exceed the temperature limits of smoke alarms (32°F-100°F), heat alarms are installed.



## PHOTOVOLTAIC AND ENERGY STORAGE SYSTEM INTERCONNECTION REQUIREMENTS

- 10** The inverter installation meets the requirements of one of the items below:
  - a) Supply-side connection complies with power source continuous output rating, conductor size, over current protection, connection, and ground fault requirements in NEC 705.11
  - b) Load-side connection complies with 705.12 and can meet the 120% busbar rating allowance in a residence
  - c) Load-side Power Control Systems which use controls to prevent overcurrent of equipment are listed to UL1741 CRD and comply with monitoring, setting, overcurrent protection, single power source ratings, and access requirements in NEC 705.13
  - d) Load-side distribution equipment listed to combine sources and supply loads

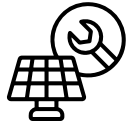

## PV SYSTEM ELECTRICAL CODE INSTALLATION REQUIREMENTS

- 11** Major electrical components, including PV modules, DC-to-DC converters, and inverters, are identified for use in PV systems.
- 12** Inverters are listed as utility-interactive in accordance with UL 1741.
- 13** PV Modules are listed as UL 1703, UL 61730-1, or UL 61730-2.
- 14** PV panel systems and array mounting systems are listed and identified with a fire classification in accordance with UL 2703.
- 15** The PV array consists of no more than 2 series strings per inverter input and no more than 4 source circuit strings in total per inverter.
- 16** The maximum PV DC system voltage for a single-family home or duplex is limited to 600Vdc. Use either the checklist shown the general installation guide or methods described in 690.7(A)(1) or 690.7(A)(3) to ensure the system is designed and connected so that 600Vdc is not exceeded on the average coldest day of the year.
- 17** PV system circuits on buildings meet requirements for controlled conductors.
  - a) Controlled conductors more than one foot from the array are capable of being shutdown to below 30 volts within 30 seconds
  - b) PV array wiring within the array is either listed to the PV Hazard Control product safety standard (UL3741) or limited to not more than 80 volts within 30 seconds of rapid shutdown initiation.
- 18** The PV System disconnecting means is sized for the maximum short circuit current and voltage and installed in a readily accessible location.



## STRUCTURAL PV ARRAY MOUNTING AND INSTALLATION LOCATION REQUIREMENTS

- 19** PV arrays are located to meet the IRC fire setback and access pathway requirements. At least two pathways not less than 3 feet wide are provided on separate roof planes from the lowest roof edge to ridge. At least one pathway is on the street or driveway side of the roof. PV arrays occupying less than 1/3 of the roof area are set back 1.5 feet on both sides of the horizontal ridge. PV arrays occupying more than 1/3 of the roof area have a 3 foot setback on both sides of a horizontal ridge.
- 20** The weight of the PV system is 4 lbs/square foot or less.
- 21** The attachment points of the mounting system are either staggered or installed in a low snow load (10 psf or less) and low wind load (120 mph or less) location.
- 22** The maximum spacing in inches between adjacent attachment points of the mounting system is either 2 feet or less or no larger than 6 feet in a low snow load (10 psf or less) and low wind load (120 mph or less) location.
- 23** How many roof surfaces at different slopes and/or orientations will be used for installation? \_\_\_\_\_
- 24** The PV array is flush mounted (parallel to roof) and the distance off the roof is between 2" and 10".
- 25** The individual roof structure appears to be structurally sound, without signs of alterations or significant structural deterioration or sagging. There are no visually apparent disallowed rafter holes, notches or truss modifications, and no visually apparent structural decay or unrepaired fire damage. Roof sag, measured in inches is not more than the rafter or ridge beam length in feet divided by 20.
- 26** What is the roof covering material? \_\_\_\_\_ Standing seam metal roofs are limited to a design snow load of no greater than 15 psf.
- 27** What is the slope of the roof? If multiple roof faces are used that have different slopes, each slope should be recorded here \_\_\_\_\_



# FIELD INSPECTION CHECKLIST



## HELPFUL TIP

Numbers that correspond to the requirement in the permitting checklist are provided next to the same requirement in the field inspection checklist.

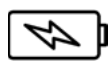

## ENERGY STORAGE SYSTEM REQUIREMENTS

Make sure all ESS disconnects and circuit breakers are in the open position and verify the following:

- 1** All work done in a neat and workmanlike manner (NEC 110.12).
- 2** Equipment installed, listed, and labeled according to the approved plan and manufacturers' instructions (e.g., ESS units, battery units, inverters, disconnects). (1- 3)
- 3** ESS equipment model numbers, quantity, and location according to the approved plan. (see PV+ESS general installation guideline for additional information)
  - a) ESS units no greater than 20 kWh each. (4)
  - b) ESS units have either 3 foot spacing between units or ESS unit has undergone large-scale fire testing and AHJ has approved closer spacing between units.
  - c) A 3 foot space between unit and doors or windows entering the dwelling unit are required. (5, 6)
  - d) ESS maximums are followed (40 kWh inside dwelling or 80 kWh in garage and elsewhere). (7)
- 4** Access and working space for ESS equipment such as ESS units, battery units, inverters, disconnecting means, and panelboards is adequate. Working space is at least 30 inches in width, 6.5 feet in height and 4 feet in depth or the width, height and depth of the equipment, whichever is greater.
- 5** Grounding/bonding of ESS units, battery units, inverters, conduit and other electrical equipment according to the NEC and manufacturer's instructions.
- 6** Conduit and other wiring methods installation according to the NEC and the approved plan. (11)
- 7** Conductors, cables, and conduit types, sizes, and markings according to the approved plan. (11)
- 8** Overcurrent devices are the type and size according to the approved plan. (11)
- 9** Disconnects according to the approved plan and properly located as required by the NEC. (11)
- 10** For grid-connected systems, documentation is provided to show that ESS meets utility interconnection requirements.
- 11** PV system electrical interconnection point (supply-side or load-side connection, load-side power control systems, and load-side distribution equipment) complies with approved plan. (11)
- 12** For garage-installed ESS mounted on end wall of garage, vehicle protection is installed where required. (8)
- 13** For ESS installed in conditioned spaces, any required smoke alarms are installed. (9)
- 14** For ESS installed in unconditioned indoor spaces that can exceed the temperature limits of smoke alarms (32°F-100°F), heat alarms are installed. (10)



## PHOTOVOLTAIC ELECTRICAL AND STRUCTURAL REQUIREMENTS

Make sure all PV disconnects and circuit breakers are in the open position and verify the following:

- 1** All work done in a neat and workmanlike manner.
- 2** PV module model number, quantity, and location according to the approved plan.
- 3** Array mounting system and structural connections according to the approved plan and manufacturers' instructions. (22-30)
- 4** Roof penetrations flashed/sealed according to the approved plan and manufacturers' instructions.
- 5** Exposed cables are properly secured, supported, and routed to prevent physical damage.
- 6** Conduit installation according to NEC 690.31 and the approved plan. (17)
- 7** Firefighter access according to IRC R324 and the approved plan. (21)
- 8** Roof-mounted PV mounting system and modules have sufficient fire classification (15)
- 9** Grounding/bonding of rack, modules, inverter(s), and other electrical equipment according to the manufacturer's instructions.
- 10** Equipment installed, listed, and labeled according to the approved plan and manufacturers' instructions (e.g., PV modules, inverters, dc-to-dc converters, rapid shutdown equipment). (12-14)
- 11** For grid-connected systems, inverter is marked "interactive," or documentation is provided to show that inverter meets utility interconnection requirements. (13)
- 12** Conductors, cables, and conduit types, sizes, and markings according to the approved plan. (16, 17, 19)
- 13** Overcurrent devices are the type and size according to the approved plan.
- 14** Disconnects according to the approved plan and properly located as required by the NEC. (20)
- 15** PV system electrical interconnection point (supply-side or load-side connection, loadside power control systems, and load-side distribution equipment) complies with approved plan. (11)
- 16** PV system markings, labels, and signs according to the approved plan.
- 17** PV system equipment grounding conductors installed according to the approved plan.
- 18** Access and working space is provided for PV equipment such as inverters, disconnecting means, and panelboards (not required for PV modules).
- 19** The rapid shutdown system is installed and operational according to the approved plan and manufacturers' instructions. (19)





# SUPPORTING RESOURCES

International Code Council "2021 International Fire Code", Oct. 2020,  
<https://codes.iccsafe.org/content/IFC2021P1>

International Code Council "2021 International Residential Code", Dec. 2020,  
<https://codes.iccsafe.org/content/IRC2021P1>

National Fire Protection Association. "NFPA 70®." NFPA 70®: National Electrical Code®, Delmar Cengage Learning, 18 Sept. 2019, <https://www.nfpa.org/codes-and-standards/all-codes-and-standards/list-of-codes-and-standards/detail?code=70&access=open>

"National Simplified Residential PV and Energy Storage Permit Guidelines." SolSmart, <https://solsmart.org/resources/national-simplified-residential-pv-and-energy-storage-permit-guidelines/>



# APPENDIX A: SOLAR AND/OR ESS PERMIT APPLICATION

## FOR OFFICE USE ONLY

Application Number: \_\_\_\_\_

Permit Number: \_\_\_\_\_

Issued By: \_\_\_\_\_

Date Applied: \_\_\_\_\_

Date Issued: \_\_\_\_\_

## SECTION 1 - GENERAL INFO

PROJECT ADDRESS \_\_\_\_\_

PROPERTY OWNER'S NAME \_\_\_\_\_

PHONE NUMBER \_\_\_\_\_

EMAIL \_\_\_\_\_

PROPERTY OWNER'S MAILING ADDRESS (IF DIFFERENT FROM PROJECT ADDRESS) \_\_\_\_\_

## SECTION 2 - PROJECT DETAILS

### BUILDING TYPE/EXISTING USE

SINGLE FAMILY

DUPLEX

MULTI-FAMILY

COMMERCIAL / INDUSTRIAL

NEW CONSTRUCTION

OTHER: \_\_\_\_\_

### NEW OR EXISTING PV SYSTEM

NEW SYSTEM

ADDITIONAL SYSTEM

SYSTEM REPLACEMENT

### PV SYSTEM TYPE

ROOF MOUNTS

GROUND MOUNTS

BUILDING INTEGRATED/ OTHER

### INVERTER CONFIGURATION

STRING INVERTER

STRING INVERTER W/ DC CONVERTERS

MICROINVERTERS OR AC MODULES

TOTAL PV SYSTEM SIZE \_\_\_\_\_ kW DC

TOTAL SQ. FT. OF PV SYSTEM \_\_\_\_\_ SQ FT

PROJECT VALUATION \$ \_\_\_\_\_

INCLUDES ENERGY STORAGE SYSTEM  YES  NO

TOTAL SYSTEM CAPACITY RATING \_\_\_\_\_ kWh

POWER RATING \_\_\_\_\_ kW

AC  DC

### PROJECT DESCRIPTION:

\_\_\_\_\_  
\_\_\_\_\_  
\_\_\_\_\_  
\_\_\_\_\_

### SECTION 3 - CONTRACTOR INFORMATION

---

CONTRACTOR BUSINESS NAME	CONTRACTOR LICENSE NUMBER	
--------------------------	---------------------------	--

---

BUSINESS ADDRESS

---

CONTRACTOR CONTACT NAME	PHONE NUMBER	EMAIL
-------------------------	--------------	-------

### SECTION 4 - PERMIT FEE

Submit permit fee according to building department instructions.

### SECTION 5 - IMPORTANT NOTICE

A permit must be obtained for all installations or alterations of electrical equipment BEFORE WORK STARTS. Refer to the EVSE Permitting Checklist for additional documents required. Failure to provide all required documents, including **(1) Site Plan, (2) Electrical Diagram, and (3) Specification Sheets and Installation Manuals** will delay permit approval. All permits expire six (6) months after the date of issuance. Failure to start the work authorized by a permit within this six-month period renders the permit invalid and a new permit must be obtained. Once work begins, noticeable progress must continue until completion. All work must be completed within eighteen (18) months of a permit issue date.

Please Submit the following additional documents with the EVSE Permit Application:

- Site Plan
- Electrical Diagram
- EVSE Specification Sheets and Installation Manuals
- Transformer Specification Sheets
- Load Calculation
- Automatic Load Management System
- Specification sheet if applicable

#### Submit Permit Application

Submit permit application according to building department instructions.

### SECTION 6 - APPLICANT SIGNATURE

I, the undersigned, certify that I have proper authority to apply for this permit, that the Contractor has obtained a signed contract from the Property Owner for the specified work, that all contractors have consented to being listed, and that all the information contained on this application is true and accurate to the best of my knowledge.

---

NAME	TITLE
------	-------

---

SIGNATURE	DATE
-----------	------



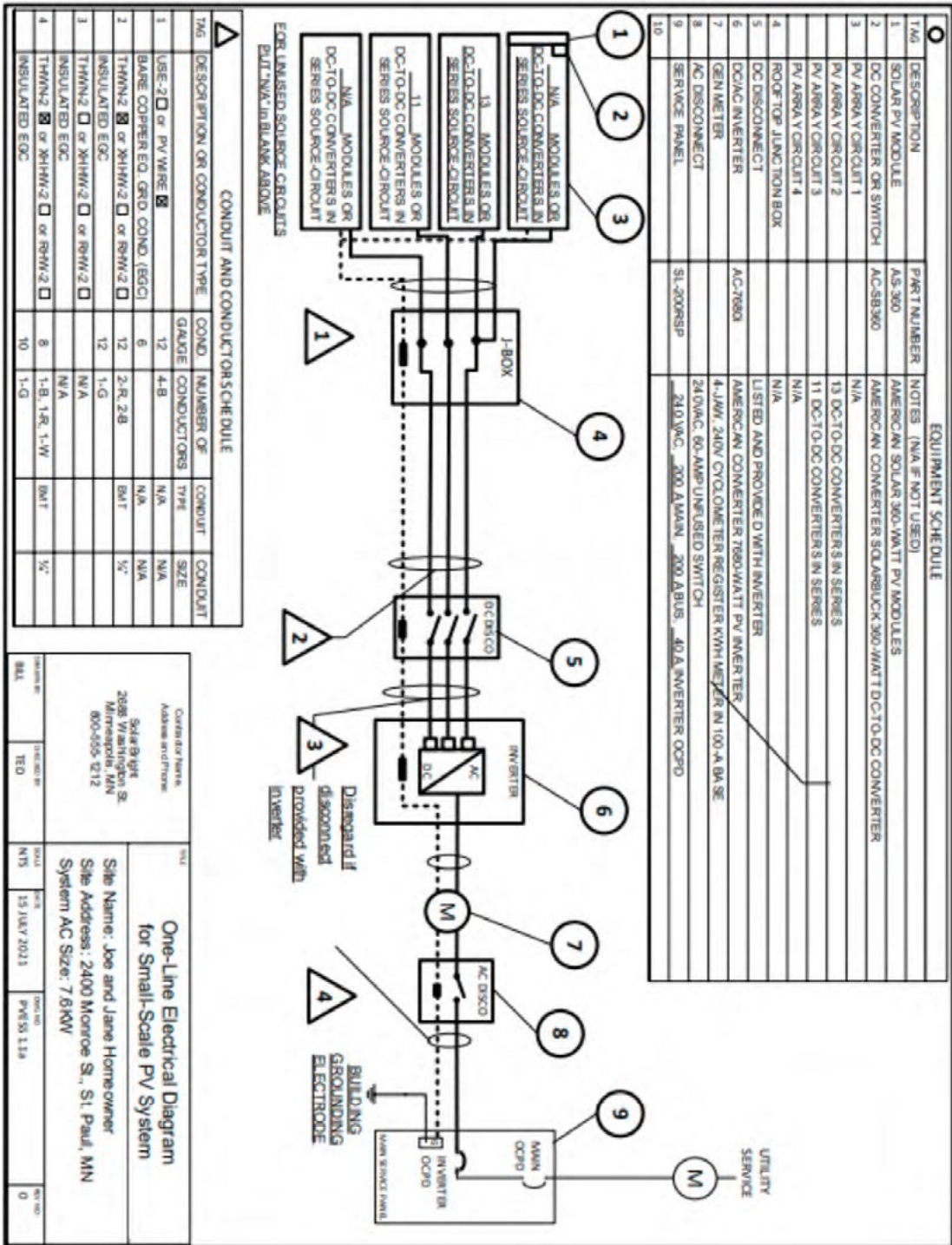

**FIGURE 10: ONE LINE PV ONLY WITH DC CONVERTERS**



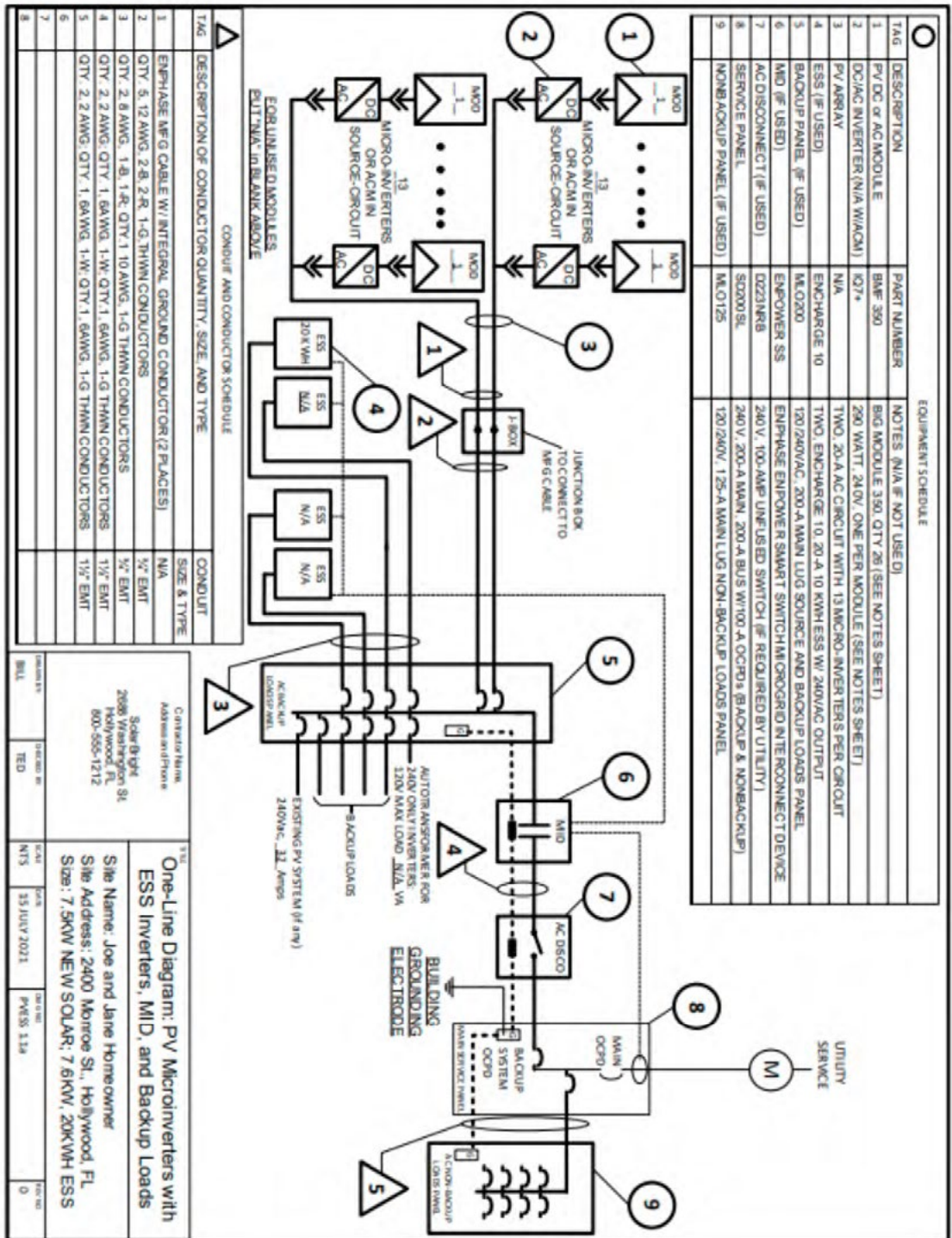

**FIGURE 12: ONE-LINE PV AND ESS WITH MICROINVERTERS AND MID**

PV MODULE RATINGS @ STC	
MODULE MAKE	AMERICAN SOLAR
MODULE MODEL	AS-360
MAX POWER-POINT CURRENT (I <sub>mp</sub> )	9.1 A
MAX POWER-POINT VOLTAGE (V <sub>mp</sub> )	39.4 V
OPEN-CIRCUIT VOLTAGE (V <sub>oc</sub> )	47.4 V
SHORT-CIRCUIT CURRENT (I <sub>sc</sub> )	9.7 A
MAX SERIES FUSE (I <sub>OPD</sub> )	25 A
MAXIMUM POWER (P <sub>max</sub> )	360 W
MAX VOLTAGE (TYP 600V <sub>oc</sub> )	1000 V
VOC TEMP COEFF (mV/°C or %/°C)	-0.28

NOTES FOR ALL DRAWINGS:	
OOPD = OVERCURRENT PROTECTIVE DEVICE NATIONAL ELECTRICAL CODE® REFERENCES SHOWN AS (NEC XXX.XX)	

DC-TO-DC CONVERTER RATINGS (if used)	
CONVERTER MAKE	
CONVERTER MODEL	
MAX CURRENT	
MAX VOLTAGE	
MAXIMUM POWER	
MAX OUTPUT CURRENT (TYP 600V <sub>oc</sub> )	

INVERTER RATINGS	
INVERTER MAKE	AMERICAN CONVERTER
INVERTER MODEL	AC-295I
MAX DC VOLT RATING	80 V
MAX POWER @ 40°C	295 W
NOMINAL AC VOLTAGE	240 V
MAX AC CURRENT	1.23 A
MAX OCPD RATING	20 A

*SIGN FOR PV DC DISCONNECT (if used)	
PHOTOVOLTAGE POWER SOURCE	
MAX VOLTAGE	V
MAX CIRCUIT CURRENT	A
MAX OUTPUT CURRENT	A

WARNING: ELECTRICAL SHOCK HAZARD—LINE AND LOAD MAY BE ENERGIZED IN OPEN POSITION

*SIGN FOR PV SYSTEM DISCONNECT (if used)	
PV SYSTEM DISCONNECT	
AC OUTPUT CURRENT	32 A
NOMINAL AC VOLTAGE	240 V

*SIGN FOR ESS DISCONNECT (if used)	
ESS DISCONNECT	
ESS VOLTAGE (AC OR DC)	240 VAC

\*NOTE: MICROINVERTER, LAND AC, MODULE SYSTEMS DO NOT NEED DC DISCONNECT SIGN SINCE MARKING ON PV/MODULE COVERS NEED INFORMATION

SOLAR PV SYSTEM EQUIPPED WITH RAPID SHUTDOWN	
TURN RAPID SHUTDOWN OFF BY PRESSING THE "OFF" POSITION TO SHUTDOWN PV SYSTEM AND REDUCE SHOCK HAZARD IN ARRAY	

NOTES FOR INVERTER CIRCUITS

- IF UTILITY REQUIRES A VISIBLE BREAK SWITCH, DOES THIS SWITCH MEET THE REQUIREMENT? YES  NO  N/A
- IF GENERATION METER REQUIRED, DOES THIS METER SOCKET MEET THE REQUIREMENT? YES  NO  N/A
- SIZE INVERTER OUTPUT CIRCUIT (AC) CONDUCTORS ACCORDING TO INVERTER OCPD AMPERE RATING. (See Table 705.12)
- DOES TOTAL SUPPLY BREAKERS COMPLY WITH:
  - 20% BUSBAR RULE IN 705.12(B) (2017 NEC)
  - SUM OF BRANCH BREAKERS
  - POWER CONTROL SYSTEMS
  - LISTED EQUIPMENT FOR COMBINING SOURCES

NOTE FOR ABRAV CIRCUIT WARNING

LOWEST EXPECTED AMBIENT TEMPERATURE BASED ON ASHRAE MINIMUM MEAN EXTREME DRY BULB TEMPERATURE FOR ASHRAE LOCATION MOST SIMILAR TO INSTALLATION LOCATION. LOWEST EXPECTED AMBIENT TEMP: -12 °C

NOTE FOR DISTRIBUTION PANELS

THIS PANEL FED BY MULTIPLE SOURCES (UTILITY AND SOLAR)

WARNING: INVERTER OUTPUT CONNECTION: DO NOT RELOCATE THIS OVERCURRENT DEVICE.

NOTE FOR SUM OF BREAKERS OPTION (if used)

WARNING: TOTAL RATING OF ALL OVERCURRENT DEVICES EXCLUDING MAIN SUPPLY OVERCURRENT DEVICE SHALL NOT EXCEED CAPACITY OF BUSBAR

**FIGURE 13: NOTES FOR ONE-LINE PV AND ESS WITH MICROINVERTERS AND MID**









PV MODULE RATINGS @ STC	
MODULE MAKE	AMERICAN SOLAR
MODULE MODEL	AS-360
MAX POWER-POINT CURRENT (I <sub>mp</sub> )	9.1 A
MAX POWER-POINT VOLTAGE (V <sub>mp</sub> )	39.4 V
OPEN-CIRCUIT VOLTAGE (V <sub>oc</sub> )	47.4 V
SHORT-CIRCUIT CURRENT (I <sub>sc</sub> )	9.7 A
MAX SERIES FUSE (OCPD)	25 A
MAXIMUM POWER (P <sub>max</sub> )	360 W
MAX VOLTAGE (TYP 600V <sub>dc</sub> )	1000 V
VOC TEMP COEFF (1mV/C <input type="checkbox"/> or %/C <input checked="" type="checkbox"/> )	-0.28

NOTES FOR ALL DRAWINGS:	
OCPD = OVERCURRENT PROTECTIVE DEVICE	
NATIONAL ELECTRICAL CODE® REFERENCES SHOWN AS (NEC XXXXX)	

DC-TO-DC CONVERTER RATINGS (if used)	
CONVERTER MAKE	AMERICAN CONVERTER
CONVERTER MODEL	AC-360
MAX CURRENT	12 A
MAX VOLTAGE	80 V
MAXIMUM POWER	360 W
MAX OUTPUT CIRCUIT V (TYP 600V <sub>dc</sub> )	600 V

INVERTER RATINGS	
INVERTER MAKE	AMERICAN CONVERTER
INVERTER MODEL	AC-7980I
MAX DC VOLT RATING	80 V
MAX POWER @ 40°C	7980 W
NOMINAL AC VOLTAGE	240 V
MAX AC CURRENT	33 A
MAX OCPD RATING	40 A

*SIGN FOR PV DC DISCONNECT (if used)	
PHOTOVOLT/AC POWER SOURCE	
MAX VOLTAGE	575 V
MAX CIRCUIT CURRENT	15 A
MAX OUTPUT CURRENT	12 A

WARNING: ELECTRICAL SHOCK HAZARD—LINE AND LOAD MAY BE ENERGIZED IN OPEN POSITION

*SIGN FOR PV SYSTEM DISCONNECT (if used)	
PV SYSTEM DISCONNECT	
AC OUTPUT CURRENT	32 A
NOMINAL AC VOLTAGE	240 V

*SIGN FOR ESS DISCONNECT (if used)	
ESS DISCONNECT	
ESS VOLTAGE (AC OR DC)	240 V AC

\*NOTE: MICROINVERTER AND AC MODULE SYSTEMS DO NOT NEED DC DISCONNECT SIGN SINCE MARKING ON PV MODULE COVERS NEEDED INFORMATION

**SOLAR PV SYSTEM EQUIPPED WITH RAPID SHUTDOWN**

TURN RAPID SHUTDOWN OFF IN POSITION TO SHUTDOWN PV SYSTEM AND REDUCE SHOCK HAZARD IN PANEL

\*NOTE: MICROINVERTER AND AC MODULE SYSTEMS DO NOT NEED DC DISCONNECT SIGN SINCE MARKING ON PV MODULE COVERS NEEDED INFORMATION

**NOTES FOR INVERTER CIRCUITS**

1) IF UTILITY REQUIRES A VISUAL BREAK SWITCH, DOES THIS SWITCH MEET THE REQUIREMENT? YES  NO  N/A

2) IF GENERATION METER REQUIRED, DOES THIS METER SOCKET MEET THE REQUIREMENT? YES  NO  N/A

3) SIZE INVERTER OUTPUT CIRCUIT (AC) CONDUCTORS ACCORDING TO INVERTER OCPD AMPERE RATING. (See Table 705.12)

4) DOES TOTAL SUPPLY BREAKERS COMPLY WITH:  
a) 100% SUBBAR RULE IN 705.12(B)(2017 NEC)  
b) SUM OF BRANCH BREAKERS  
c) POWER CONTROL SYSTEMS  
d) LISTED EQUIPMENT FOR COMBINING SOURCES

**NOTES FOR DISTRIBUTION PANELS**

THIS PANEL FED BY MULTIPLE SOURCES (UTILITY AND SOLAR)

SIGN FOR 120% OVERTON (if used)

WARNING:  
INVERTER OUTPUT CONNECTION: DO NOT RELOCATE THIS OVERCURRENT DEVICE

**NOTES FOR SUM OF BREAKERS OPTION (if used)**

WARNING:  
TOTAL RATING OF ALL OVERCURRENT DEVICES EXCLUDING MAIN SUPPLY OVERCURRENT DEVICE SHALL NOT EXCEED CAPACITY OF BUSBAR.

OWNER NAME	2088 Washington St Cary, NC 800-555-1212
OWNER BILL	OWNER TED
DATE	DATE
NTS	15 JULY 2021
PROJECT	PV/ESS 12A
PAGE	0

**Notes for One-Line Diagram for PV and Energy Storage Systems**

Site Name: Joe and Jane Homeowner  
Site Address: 2400 Monroe St., Raleigh, NC  
Size: 7.1kW NEW SOLAR, 7.6kW, 20KWH ESS

**FIGURE 17: NOTES FOR ON-LINE PV AND ESS WITH STRING INVERTERS WITH DC CONVERTERS AND MID**

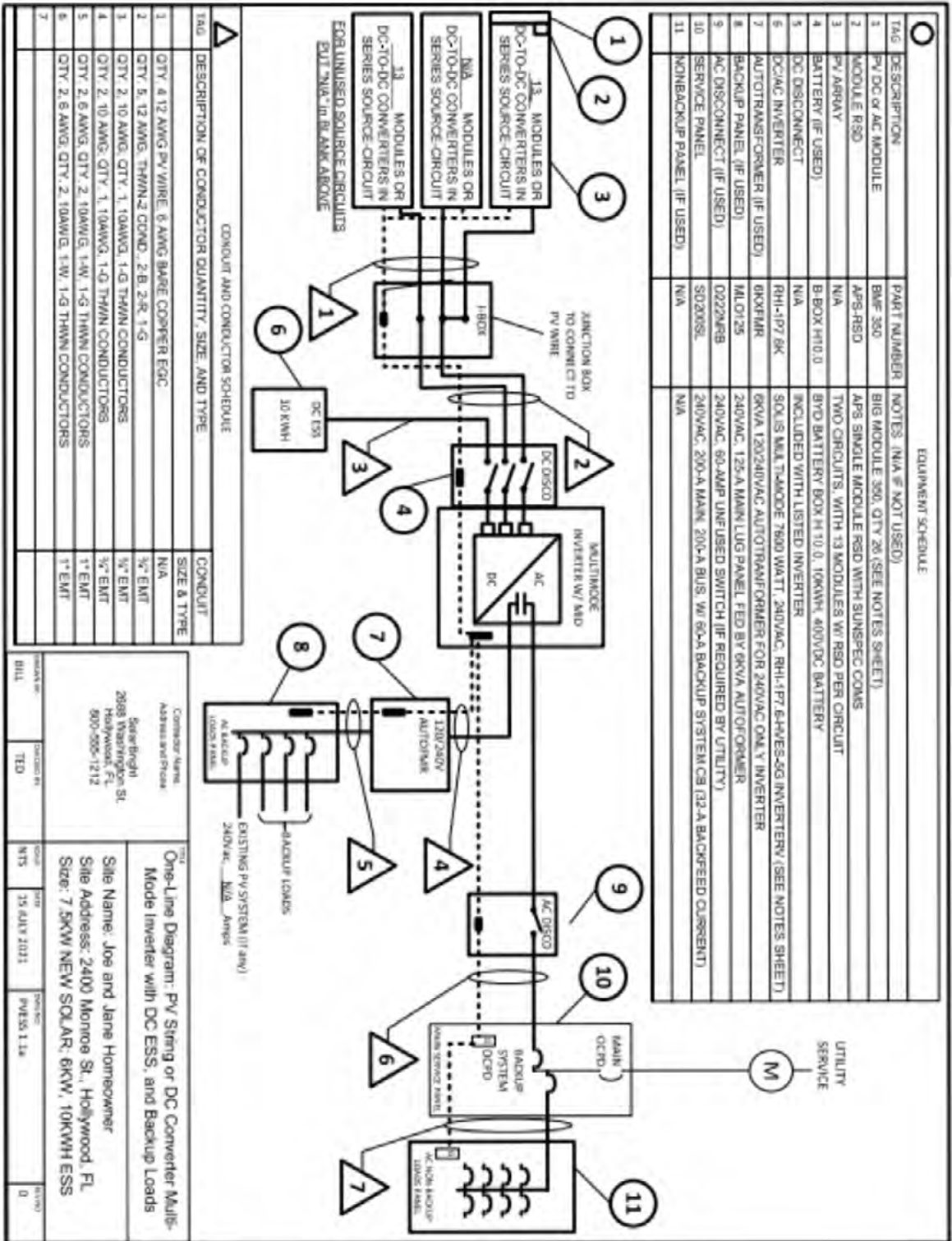

**FIGURE 18: ONE-LINE PV AND ESS WITH MULTI-MODE INVERTER**



Earth Advantage® is a 501(c)(3) nonprofit focused on helping to create an informed and humane residential real estate marketplace that: acknowledges both the climate impacts of housing and the impact climate has on housing; provides all homebuyers and renters with access to sustainability-related information about a home; supports equitable housing outcomes, protecting those most vulnerable from the effects of climate change, and; recognizes both the personal and societal value that climate-friendly housing creates. Visit [earthadvantage.org](http://earthadvantage.org) to learn more.



New Buildings Institute (NBI) is a nonprofit organization working to advance energy efficiency and decarbonization of the built environment. Our efforts are imperative to keeping energy costs affordable, cutting carbon emissions that are fueling climate change, and delivering on improved health, safety, and resiliency for all. We work collaboratively with industry market players—governments, utilities, advocates, AEC professionals, and others—to drive leading-edge design, innovative technologies, and public policies and programs for scale. Throughout its 25-year history, NBI has become a trusted and independent resource helping to create buildings that are better for people, communities, and the planet. Visit [newbuildings.org](http://newbuildings.org) to learn more.

Electric Vehicle Supply Equipment (EVSE) Permitting & Inspection Guidelines is made available under a Creative Commons Attribution 4.0.