

SOLAR AND ENERGY STORAGE SYSTEM

**PERMITTING &
INSPECTION GUIDELINES**

**FOR PERMITTING AND INSPECTING ENERGY
STORAGE OR COMBINED SOLAR AND ENERGY
STORAGE SYSTEMS (ESS) IN MULTIFAMILY &
OFFICE BUILDINGS**

**2020 NATIONAL ELECTRICAL CODE (NEC),
2021 INTERNATIONAL BUILDING CODE (IBC)
AND 2021 INTERNATIONAL FIRE CODE (IFC)**

TABLE OF CONTENTS

Acknowledgements	2
Introduction	3
Permit Submission Requirements.....	6
General Installation Guide	7
Energy Storage System Requirements.....	7
Energy Storage System Installation Requirements	7
Energy Storage System Size and Location Requirements	8
Photovoltaic and Energy Storage System Interconnection Requirements...	10
PV System Electrical Code Installation Requirements.....	11
Structural PV Array Mounting and Installation Location Requirements	12
Plan Review Checklist	13
Field Inspection Checklist	15
Supporting Resources	17
Appendix A: Solar and/or ESS Permit Application	19
Appendix B: Solar and Energy Storage Standard Electrical Line Diagrams	21

ACKNOWLEDGMENTS

This permitting and inspection guide was developed in collaboration between New Buildings Institute, Earth Advantage, and several expert reviewers, including Pete Jackson, Electrical Specialist, City of Bakersfield, Keith Winston, Code Official and Solar Coordinator, Department of Community and Regulatory Affairs, Washington, DC, Bryan Holland, Senior Technical Field Representative, National Electrical Manufacturer’s Association, and Tesla.



ACKNOWLEDGMENT AND DISCLAIMER

This material is based upon work supported by the Department of Energy and Office of Energy Efficiency and Renewable Energy (EERE), under Award Number EE0009457.

This report was prepared as an account of work sponsored by an agency of the United States Government. Neither the United States Government nor any agency thereof, nor any of their employees, makes any warranty, express or implied, or assumes any legal liability or responsibility for the accuracy, completeness, or usefulness of any information, apparatus, product, or process disclosed, or represents that its use would not infringe privately owned rights. Reference herein to any specific commercial product, process, or service by trade name, trademark, manufacturer, or otherwise does not necessarily constitute or imply its endorsement, recommendation, or favoring by the United States Government or any agency thereof. The views and opinions of authors expressed herein do not necessarily state or reflect those of the United States Government or any agency thereof. The solar and energy storage criteria in this guideline is based on

SolSmart’s National Simplified Residential PV and Energy Storage Permit and Inspection Guidelines. For more information about SolSmart, a program intended to provide no-cost technical assistance to jurisdictions who want to make it faster, easier and more affordable for their communities to go solar visit www.solsmart.org. The SolSmart guide is supported by the Department of Energy and Office of Energy Efficiency and Renewable Energy (EERE), under Award Number DEEE0007155.

Use of Solar and Energy Storage System Permitting and Inspection Guidelines is permitted on a royalty-free basis. The authors claim no rights in and make no representations as to the contents or use of the 2020 National Electrical Code (NEC), the 2021 International Residential Code (IRC) and the 2021 International Fire Code (IFC). The authors further make no representations as to the suitability of this guide for any purpose, and all content is provided as-is. Projects are expected to meet locally adopted codes and should refer to the 2020 NEC, 2021 IRC and 2021 IFC and local amendments to ensure full compliance.

An aerial photograph of a parking lot. In the foreground, a large, rectangular solar panel array is mounted on a white metal frame. The array is tilted and covers a charging station. Several cars are parked in the lot, including a white car directly under the solar panel. The background shows more cars and trees. The image is split diagonally, with the top right portion being white and the bottom left portion showing the parking lot.

INTRODUCTION

More and more, buildings are incorporating energy storage systems with photovoltaic systems to both provide a backup power source to a building and reduce utility bills. This is a new aspect of building operations that a growing number of jurisdictions will need to address. This guide provides an overview of code requirements for the installation of energy storage systems (ESS) and combined solar and energy storage system installations. By providing a specific and replicable list of permitting and inspection requirements, local jurisdictions can reduce informational barriers and help ensure the design and installation of solar and energy storage are consistent and code-compliant. This guide references the most applicable requirements for the 2020 National Electrical Code (NEC), the 2021 International Building Code (IBC), and the International Fire Code (IFC). Not all requirements are covered by these checklists, but they do include the most important life and safety aspects of the installation and can be used to highlight “common mistakes” made by installers. While these guidelines are geared primarily toward implementing the 2020 NEC, 2021 IBC, and 2021 IFC, jurisdictions enforcing and contractors using earlier editions of these codes can make use of these guidelines which include code requirements that increase safety and reliability.

HOW TO USE THIS GUIDE

Read this guide for an overview of code requirements for the installation of energy storage systems (ESS) and combined solar and energy storage system installations. The process described in this guide can be adopted as-is, used as a reference, or adapted to incorporate specific local requirements. Designers, contractors, and building owners can use this guide to gain an understanding of what to expect in the permitting and inspection processes.

Jurisdictions and building departments can use this guide as a starting point for conducting a plan review and inspection for solar and energy storage installations. When adopting or adapting this guide, departments and their permit applicants are advised to reference all applicable local codes and requirements, including different cycles of the referenced codes, as needed.

The replicable lists of permitting and inspection requirements in this guide can be used to reduce informational barriers and help ensure the design and installation are consistent and code-compliant. Any department implementing a new permitting and inspection process based on this guide is advised to provide communication, coordination, and education to key stakeholders in order to support successful implementation, including, but not limited to, the following:

- Communicate intentions with the utility company
- Inform the Fire Department of any changes
- Provide training to plan reviewers

This guide has limitations on its intended use, including the following:

✘ This solar and storage permitting and inspection guide does not include requirements for any service upgrades or other electrical work. If the required load calculation demonstrates a service upgrade is needed, this streamlined permitting and inspection guide cannot be used to determine code compliance of the service upgrade.

✘ The electrical requirements in this guide primarily focus on the requirements in Article 625: Electric Vehicle Power Transfer System of the National Electrical Code.

✘ This solar and storage permitting and inspection guide does not include requirements for indoor installation of infrastructure for EV batteries that require additional ventilation, including flooded lead-acid or nickel-iron batteries.

✘ Where electrical service or metering upgrades are required, another permit may be required before this guide can be followed.

Additional general electrical requirements detailed in chapters one through four of the National Electrical Code also apply but are not listed throughout this guide. These include, but are not limited to, the following:

- Electrical equipment is installed in a neat and workmanlike manner. (NEC 110.12)
- Electrical connections of the circuit conductors and equipment grounding conductor connections are secure. (NEC 110.14. 250.148(A))
- Installed branch circuit wiring is properly secured, supported, and routed to prevent physical damage. (NEC 300.11)

PERMIT APPROVAL REQUIREMENTS

- ☑ This permitting and inspection guide is only applicable to the installation of the following applications:
 - Lithium-ion energy storage systems
 - Energy storage systems with total maximum energy capacity on site of 600kWh
 - Energy storage systems installed with simple solar systems meeting SolSmart criteria that are less than 15kW consisting of no more than 2 series strings per inverter and no more than 4 source circuits in total per inverter.

- ☑ Standard electrical diagrams are provided in Appendix B and can be used to accurately represent the ESS or combined ESS and PV installations. If the electrical system is more complex than the standard electrical diagram can effectively communicate, the project does not meet the requirements for a simplified permit application and additional information may be necessary for the jurisdiction to process the permit application.

- ☑ This permitting and inspection guide does not include any service upgrades or other electrical work. If the load calculations demonstrate a service upgrade is needed, this permitting and inspection guide cannot be used to determine compliance with code requirements for a service upgrade.

"National Simplified Residential PV and Energy Storage Permit Guidelines." SolSmart, <https://solsmart.org/resources/national-simplified-residential-pv-and-energy-storage-permit-guidelines/>



PERMIT SUBMISSION REQUIREMENTS

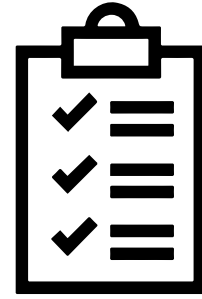

TO APPLY FOR A PERMIT, SUBMIT THE FOLLOWING:

- 1) **Permit application**¹ (see Appendix A) which includes basic information about the project, location, and installer.
- 2) **Site plan (see Appendix B) drawn to scale showing:**
 - a) Location of PV array and ESS components on the property
 - b) Primary use of the space or area where the ESS will be installed
 - c) ESS spacing
 - d) PV and ESS setback and access pathways
 - e) Fire detection, and fire suppression systems if applicable
- 3) **A standard electrical line diagram (see Appendix B) that accurately indicates:**
 - a) PV array configuration (if applicable)
 - b) Mounting details
 - c) ESS components
 - d) Conductors, cables, and conduit types, sizes, and markings
 - e) Type and size rating of overcurrent protection and disconnects
 - f) Inverters
 - g) Required signs
 - h) Connection to the premises wiring system and
 - i) Location of additional meters, main electrical service panel, distribution panels or subpanels
- 4) **Specification sheets and installation manuals for all major system components including: ESS and PV components, inverters, mounting systems, PV modules, and DC-to-DC converters.**
- 5) **Structural Load Calculation**

¹ Jurisdiction can fill this text box with link to their own permit application. A sample permit application is shown as Appendix A to this guide.

GENERAL INSTALLATION GUIDE

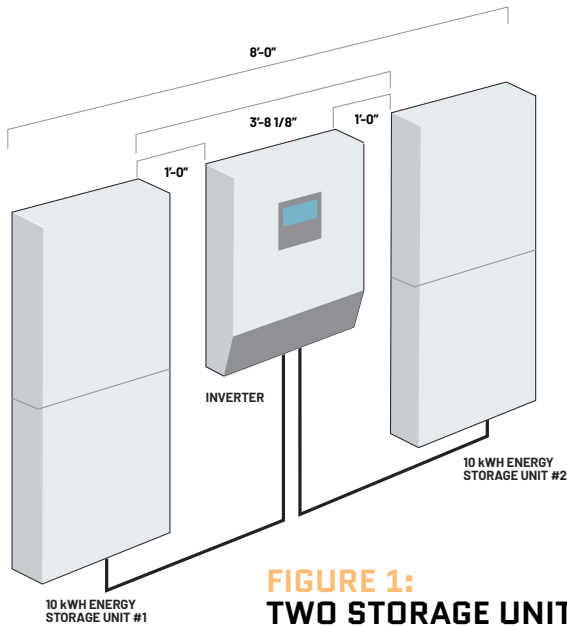

**FIGURE 1:
TWO STORAGE UNITS
COMPLYING WITH 3
FOOT SEPARATION**

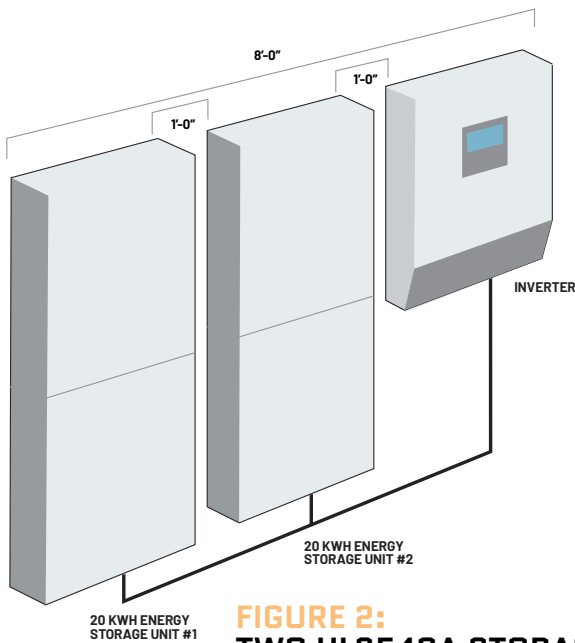

**FIGURE 2:
TWO UL9540A STORAGE
UNITS COMPLYING
WITH MANUFACTURER
INSTRUCTIONS**



ENERGY STORAGE SYSTEM REQUIREMENTS

- 1 ESS is listed to UL9540 or UL9540a by a Nationally Recognized Testing Laboratory (NRTL). (IFC 1207.3)
- 2 Inverters are certified to UL1741. (NEC 690.4(B))



ENERGY STORAGE SYSTEM INSTALLATION REQUIREMENTS

- 3 ESS is installed according to manufacturer installation instructions. (NEC 110.3(B))
- 4 All work is done in a neat and workmanlike manner. (NEC 110.12)
- 5 Access and working space for ESS equipment such as ESS units, battery units, inverters, disconnecting means, and panelboards is adequate. Working space is at least 30 inches in width, 6.5 feet in height, and 4 feet in depth or the width, height, and depth of the equipment, whichever is greater. (NEC 110.26)
- 6 Grounding/bonding of ESS units, battery units, inverters, conduit and other electrical equipment according to the NEC and manufacturer's instructions. (NEC 110.14, 250.148(A), NEC 110.3(B))

UL9540

- 7 In rooms, areas or walk-in units with ESS, explosion control is installed which provides either explosion venting, explosion prevention systems or barricades which comply with NFPA 69 or NFPA 495. (IFC 1207.6.3)
- 8 ESS units are separated by 3 feet and in groups no larger than 50kWh (IFC 1207.5.1)

UL9540A

- 9 Energy Storage Systems that have undergone large-scale fire testing to UL9540a may be spaced less than 3 feet apart if fire testing is approved by the AHJ (IFC 1207.5.1, NEC 110.3(B))



**FIGURE 3: LARGE SCALE FIRE
TESTED LABEL**

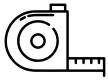

ENERGY STORAGE SYSTEM SIZE LOCATION REQUIREMENTS

- 11** EESS is located: (IFC 1207.5.3, IFC 1207.7.3)
- a) In a space that is not a dwelling unit or sleeping unit
 - b) 75 feet or below the lowest level of fire department vehicle access and
 - c) At or above the lowest level of exit discharge
- 12** ESS installed on exterior walls meets the following:
- a) ESS is separated from doors, windows, operable openings into buildings or HVAC inlets by at least 5 feet. (IFC 1207.8.4)
 - b) Within 10 feet of outdoor ESS, the area is cleared of combustibile vegetation. (IFC 1207.5.7)
 - c) Located 10 feet away (or 3 feet away if ESS is enclosed in a weatherproof enclosure of noncombustible materials) from: (IFC 1207.5.8, IFC 1207.8.3)
 - a) Any means of egress under fire conditions
 - b) Other buildings
 - c) Lot lines
 - d) Public ways
 - e) Stored combustibile or hazardous materials and
 - f) Parking spaces
- 13** For ESS installed indoors: (IFC 1207)
- a) ESS is separated from other areas of the building with a 2-hour fire barrier and 2-hour horizontal assembly (IFC 1207.7.4, IBC 707, IBC 710)
 - b) A smoke detection or radiant energy-sensing fire detection system is installed (IFC 1207.5.4, IFC 907.2)
 - c) The room or area with an ESS is protected by one of the following fire suppression systems: (IFC 1207.5.5, IFC 903.3.1.1, IFC 904)
 - a) An automatic sprinkler system that meets the requirements of Section 1207.5.5 and Section 903.3.1.1
 - b) One of the following alternative automatic fire protection systems that meets the requirements of Section 1207.5.5 and Section 904:
 - i.) Carbon dioxide extinguishing system
 - ii.) Water spray fixed systems
 - iii.) Water mist fire protection systems
 - iv.) Clean agent fire-extinguishing systems
 - v.) Fixed aerosol fire-extinguishing systems
- 14** ESS installed in a garage must meet the following requirements: (IFC 1207.9.6)
- a) If in an open parking garage, ESS is located 10 feet away or 3 feet away if ESS is enclosed in a weatherproof enclosure of noncombustible materials from:
 - a) Other buildings
 - b) Lot lines
 - c) Public ways
 - d) Stored combustibile or hazardous materials, and
 - e) Parking spaces (IFC 1207.9.3)
- 15** ESS installed within a locked gate, fence or other barrier that prevents the public from standing within 5 feet of the ESS
- b) ESS is located 50 feet or more from air inlets of building HVAC systems unless a fire alarm system can shut off ventilation system upon detection of fire
 - d) ESS is located 25 feet away from exits from the attached building if on a covered level of the parking structure
 - e) ESS is protected by an approved radiant energy-sensing fire detection system. (IFC 1207.5.4)
 - f) ESS is protected from vehicular impact by one of the following: (IFC 1207.4.5, IFC 312)
 - a) Installed in a location not subject to vehicular impact such as 4 feet or more above floor level
 - b) Protected by guard posts constructed of steel not less than 4 inches in diameter and concrete filled, spaced not more than 4 feet apart, set not less than 3 feet deep in concrete footing, with top posts not less than 3 feet above the ground, and located 3 feet or more away from the ESS
 - c) Protected by wheel barriers anchored in place located 4.5 feet or more away from the ESS or
 - d) Protected by other barriers where approved
- 15** ESS installed on the rooftop is: (IFC 1207.9.5)
- a) Located at least 5 feet away from the edge of the roof if the height of the system is 5 feet or less
 - b) Located at least the height of the system away from the edge of the roof if the height of the system is greater than 5 feet
 - c) Located within 10 feet of the fire service access point
 - d) Accessible via a stairway through a bulkhead from the building interior or exterior stairway
- 16** Rooftops with an ESS must have: (IFC 1207.9.5)
- a) Service walkways at least 5 feet in width from the access point to the ESS
 - b) Roofing materials under and within 5 feet of the ESS that are noncombustible or have a Class A ASTM E108 or UL790 rating
 - c) A Class I standpipe outlet installed on the roof level of the building or in the stairway bulkhead at the top level.
 - d) An approved radiant energy-sensing fire detection system. (IFC 1207.5.4)

The following figure illustrates the effect that the location limitations have on an ESS.

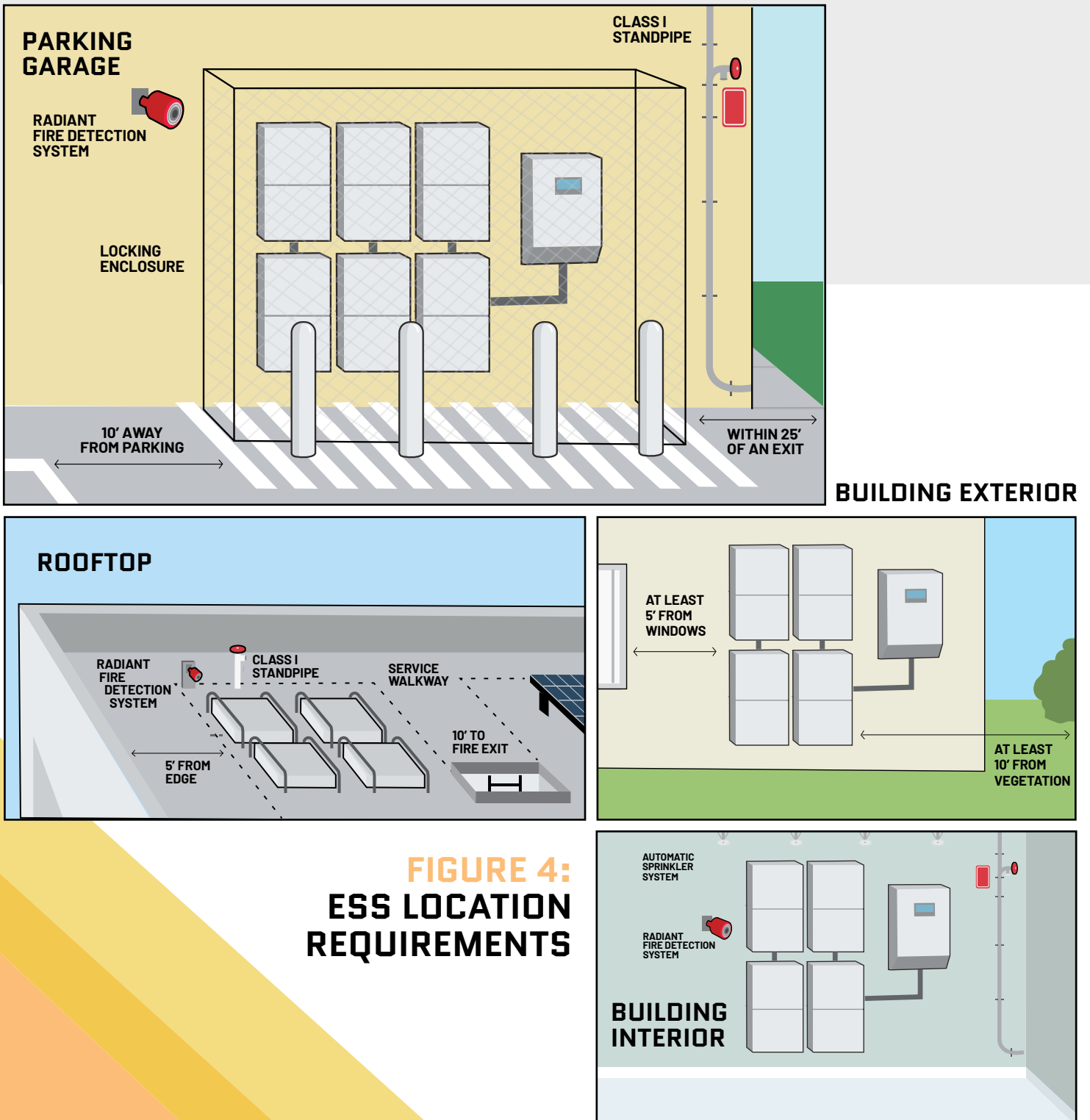



PHOTOVOLTAIC AND ENERGY STORAGE SYSTEM INTERCONNECTION REQUIREMENTS

- 17** The inverter installation meets the requirements of one of the items below: (NEC 705)
- A) Supply-side connection complies with the following: (NEC 705.11)
 - a) The sum of the power source continuous current output rating on a service does not exceed the capacity of the service conductors. (NEC 705.11 (A))
 - b) The power source output circuit conductors to the first OCPD device are no smaller than 6AWG copper and sized at 125% of maximum current or maximum current with adjustment and correction factors. (NEC 705.11 (B), 705.28)
 - c) Power source output circuit conductors are protected by an OCPD. (NEC 705.11 (C), 705.30)
 - d) When power source output circuit conductors make a connection to service outside the building, OCPD are located in a readily accessible location outside the building or where the power source conductors enter the building. (NEC 705.11 (C))
 - e) When power source output circuit conductors make their connection to the service inside a building, OCPD are either within 10 feet of conductor length in dwelling units and 16.5 feet in other than dwelling units from the point of connection to the service or located within 71 feet of conductor length with the use of current limiters from the point of connection to service. (NEC 705.11 (C))
 - B) Load-side connection complies with the following:
 - a) Each source interconnection is made at a dedicated circuit breaker or fusible disconnecting means. (NEC 705.12 (A))
 - b) The bus amp meets the 120% busbar rating allowance in a building. Table 1 displays several AC
 - C) Load-side Power Control Systems that use controls to prevent overcurrent of equipment are listed to UL1741 CRD and shall comply with the following:
 - a) Each source interconnection is made at a dedicated circuit breaker or fusible disconnecting means. (NEC 705.12 (A))
 - b) The bus amp meets the 120% busbar rating allowance in a building. Table 1: AC Interconnection Options below displays several AC Interconnection options. (NEC 705.12 (B))
 - c) Equipment containing OCPD is marked to indicate the presence of all sources (NEC 705.12 (C))
 - d) Fused disconnects are suitable for backfeed. Circuit breakers must either not be marked "line" or "load" or be specifically rated for backfeed. (NEC 705.12 (D))
 - e) Circuit breakers backfed from power sources that are interactive do not need a fastener. (NEC 705.12 (E))
 - D) Load-side distribution equipment listed to combine sources and supply loads.
 - Interconnection options. (NEC 705.12 (B))
 - c) Equipment containing OCPD is marked to indicate the presence of all sources (705.12 (C))
 - d) Fused disconnects are suitable for backfeed. Circuit breakers must either not be marked "line" or "load" or be specifically rated for backfeed. (705.12 (D))
 - e) Circuit breakers backfed from power sources that are interactive do not need a fastener. (705.12 (E))

Maximum Inverter Current	Required Inverter OCPD* Size	Minimum Conductor Size (Copper) in Conduit	Minimum Busbar/ Main Breaker Combinations Busbar Amps/Main Amps
64 Amps	80 Amps	4 AWG	400/400; 200/150
56 Amps	70 Amps	4 AWG	225/200; 250/225
48 Amps	60 Amps	6 AWG	300/300; 200/175
40 Amps	50 Amps	8 AWG	125/100; 150/125
32 Amps	40 Amps	8 AWG	225/225; 200/200; 150/125
24 Amps	30 Amps	10 AWG	150/150
16 Amps	20 Amps	12 AWG	100/100; 70/60
12 Amps	15 Amps	12 AWG	80/80

TABLE 1:
AC INTERCONNECTION OPTIONS

* Overcurrent Protection Device (OCPD)



PV SYSTEM ELECTRICAL CODE INSTALLATION REQUIREMENTS

- 18** All work done in a neat and workmanlike manner. (NEC 110.12)
- 19** Access and working space is provided for PV equipment such as inverters, disconnecting means, and panelboards (not required for PV modules). (NEC 110.26)
- 20** Exposed cables are properly secured, supported, and routed to prevent physical damage.
- 21** Grounding/bonding of rack, modules, inverter(s), and other electrical equipment according to the manufacturer's instructions. (NEC 110.3(B))
- 22** PV system markings, labels, and signs according to the NEC. (NEC 690.13(B), 690.53, 690.54, 690.56)
- 23** Major electrical components including PV modules, DC-to DC converters, and inverters, are identified for use in PV systems.
- 24** Inverters are listed as utility-interactive in accordance with UL 1741.
- 28** The maximum PV DC system voltage for a single-family home or duplex is limited to 1000Vdc. Use either the checklist shown below or methods described in 690.7(A)(1) or 690.7(A)(3) to ensure the system is designed and connected so that 1000Vdc is not exceeded on the average coldest day of the year. (NEC 690.7)
 - a) ASHRAE Extreme Annual Mean Minimum Design Dry Bulb Temperature (one source is <https://energyresearch.ucf.edu/solar-certification/solar-reference-map/>) ; Table 690.7(A)(NEC) value
 - b) Max module Voc (adjusted at minimum temperature): Rated Voc _____V x Table 690.7(A) value= _____ V
 - c) DC-to-DC converter(s) or microinverter rated maximum input voltage: _____V (must be greater than Max module Voc in (b.))
 - d) Maximum number of DC-to-DC converters allowed in series (up to 1000Vdc): _____
 - e) Maximum number of DC-to-DC converters allowed in series (up to 1000Vdc): _____
 - f) Inverter(s) rated maximum input voltage: _____ V (must be greater than g. below)
 - g) Inverter input max V: Max module Voc (b.) _____ V x max # in series= _____ V

Grid Support Utility Interactive Non Isolated Photovoltaic Inverter	
Operating Voltage Range	270 – 480Vdc
Max Input Current	10.5A _{dc}
Max Continuous Output Power	3300Wac @ 208V 3800Wac @ 240V
Voltage Min – Nom – Max	183 – 208 – 229Vac 211 – 240 – 264Vac

FIGURE 7: UTILITY INTERACTIVE INVERTER LISTING

- 25** PV Modules are listed as UL 1703, UL 61730-1, or UL 61730-2. (NEC 690.4(B))

- 26** PV panel systems and array mounting systems are listed and identified with a fire classification in accordance with UL 2703. (NEC 690.43(A), IBC 1505.9)



FIGURE 8: UL2703 LISTED GROUNDING DEVICE

- 27** The PV array consists of no more than 2 series strings per inverter input and no more than 4 source circuits strings in total per inverter.

- 30** PV system circuits on buildings meet requirements for controlled conductors.
 - a) Controlled conductors more than one foot from the array are capable of being shutdown to below 30 volts within 30 seconds
 - b) PV array wiring within the array is either listed to the PV Hazard Control product safety standard (UL3741) or limited to not more than 80 volts within 30 seconds of rapid shutdown initiation. (NEC 690.12)
- 31** The PV System disconnecting means is sized for the maximum short circuit current and voltage and installed in a readily accessible location. (NEC 690.13(A))



STRUCTURAL PV ARRAY MOUNTING AND INSTALLATION LOCATION REQUIREMENTS

FIGURE 9:
SITE PLAN WITH
FIRE SETBACK AND
ACCESS PATHWAY
REQUIREMENTS
DETAILED FOR
BUILDING SIDES
250 FEET OR
LARGER

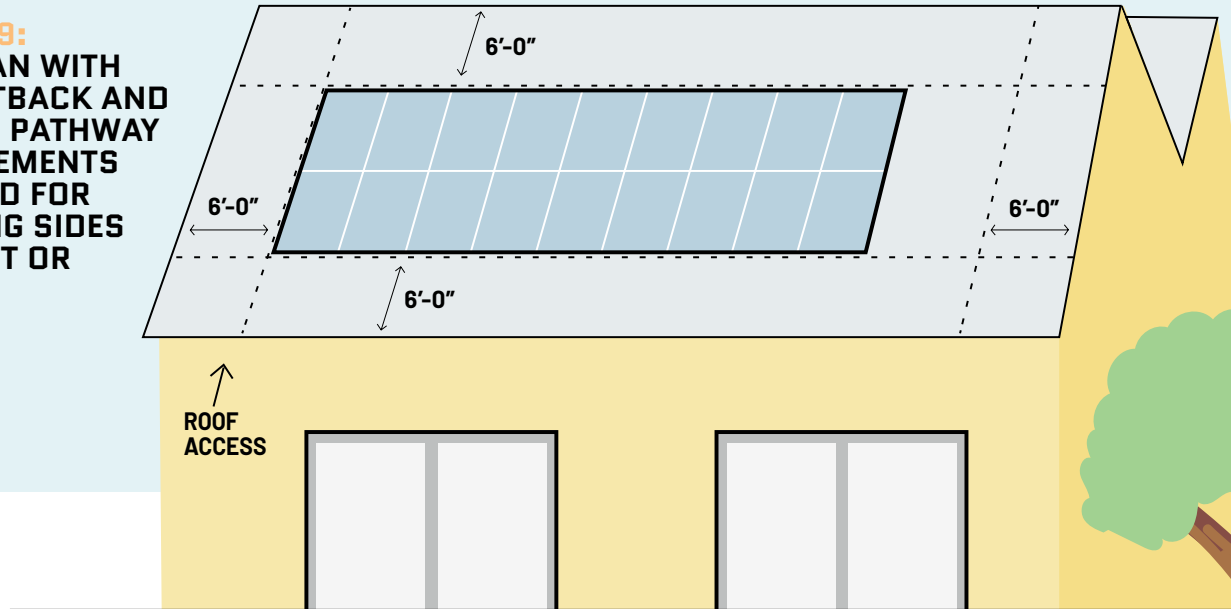

32 PV arrays are located to meet the following fire setback and access pathway requirements unless determined by the fire code official that the roof configuration is similar to that of a Group R-3 occupancy: (IFC 1205.3.1 IFC 1205.3.2)

- There is a 4-foot wide clear perimeter around the edges of the roof for building sides less than 250 feet. For building sides equal to or larger than 250 feet, 6-foot wide clear perimeter pathways are required.
- Interior pathways are provided at intervals not greater than 150 feet throughout the length and width of the roof.
- A pathway at least 4 feet wide is provided in a straight line to roof standpipes or ventilation hatches.
- A pathway at least 4 feet wide is provided around roof access hatches, with at least one pathway to a parapet or roof edge.

33 PV array determined by a fire code official that the roof configuration is similar to that of a Group R-3 occupancy must meet the following IRC fire setback and access pathway requirements.

- At least two pathways not less than 3 feet wide are provided on separate roof planes from the lowest roof edge to ridge.
- At least one pathway is on the street or driveway side of the roof.
- PV arrays occupying less than 1/3 of the

roof area are set back 1.5 feet on both sides of the horizontal ridge. PV arrays occupying more than 1/3 of the roof area have a 3-foot setback on both sides of a horizontal ridge. (IRC 324.6)

34 Roof structures are designed to resist the applicable uniform concentrated roof live loads with PV panel dead loads and with PV panels present. Roof live loads do not need to be applied if the space between the panels and the roof surface is 2 feet or less. (IBC 1607.14.4.1)

35 The roof structure is designed to accommodate PV panels or modules and ballast dead load, including concentrated loads from support frames, roof live loads, snow drift loads created by PV panels and modules if applicable, and other applicable loads. (IBC 1607.14.4.2)

36 Roof penetrations flashed/sealed according to manufacturers' instructions. (NEC 110.3(B))



PLAN REVIEW CHECKLIST



ENERGY STORAGE SYSTEM REQUIREMENTS

- 1** ESS is listed to UL9540 by a Nationally Recognized Testing Laboratory (NRTL).
- 2** Inverters are certified to UL1741.



ENERGY STORAGE SYSTEM INSTALLATION REQUIREMENTS

- 3** In rooms, areas or walk-in units with UL9540 listed ESS, explosion control is installed which provides either explosion venting, explosion prevention systems or barricades that comply with NFPA 69 or NFPA 495.
- 4** UL9540 listed ESS units are separated by 3 feet and in groups no larger than 50kWh.
- 5** UL9540a listed ESS are grouped and separated according to manufacturer instructions.

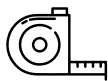

ENERGY STORAGE SYSTEM SIZE AND LOCATION REQUIREMENTS

- 6** ESS is located:
 - a) In a space that is not a dwelling unit or sleeping unit,
 - b) 75 feet or below the lowest level of fire department vehicle access, and
 - c) At or above the lowest level of exit discharge.
 - b) One of the following alternative automatic fire protection systems that meets the requirements of Section 1207.5.5 and Section 904.:
 - i.) Carbon dioxide extinguishing system
 - ii.) Water spray fixed systems
 - iii.) Water mist fire protection systems
 - iv.) Clean agent fire-extinguishing systems
 - v.) Fixed aerosol fire-extinguishing systems
- 7** ESS installed on exterior walls meets the following:
 - a) ESS is separated from doors, windows, operable openings into buildings or HVAC inlets by at least 5 feet.
 - b) Within 10 feet of outdoor ESS, area is cleared of combustible vegetation.
 - c) Located 10 feet away (or 3 feet away if ESS is enclosed in a weatherproof enclosure of noncombustible materials) from:
 - a) Any means of egress under fire conditions
 - b) Other buildings
 - c) Lot lines,
 - d) Public ways,
 - e) Stored combustible or hazardous materials, and
 - f) Parking spaces.
- 8** For ESS installed indoors:
 - a) ESS is separated from other areas of the building with a 2-hour fire barrier and 2-hour horizontal assembly.
 - b) A smoke detection or radiant energy-sensing fire detection system is installed
 - c) The room or area with an ESS is protected by one of the following fire suppression systems:
 - a) An automatic sprinkler system that meets the requirements of Section 1207.5.5 and Section 903.3.1.1
 - b) ESS is installed within a locked gate, fence or other barrier that prevents the public from standing within 5 feet of the ESS.
 - c) ESS is located 50 feet or more from air inlets of building HVAC systems unless a fire alarm system can shut off the ventilation system upon detection of fire.
 - d) ESS is located 25 feet away from exits from the attached building if on a covered level of the parking structure.
 - e) ESS is protected by an approved radiant energy-sensing fire detection system.
 - f) ESS is protected from vehicular impact by one of the following:
 - a) Installed in a location not subject to vehicular impact such as 4 feet or more above floor level, or
- 9** ESS installed in a garage must meet the following requirements:
 - a) If in an open parking garage, ESS is located 10 feet away or 3 feet away if ESS is enclosed in a weatherproof enclosure of noncombustible materials from:
 - a) Other buildings
 - b) Lot lines
 - c) Public ways
 - d) Stored combustible or hazardous materials, and
 - e) Parking spaces.

- b) Protected by guard posts constructed of steel not less than 4 inches in diameter and concrete filled, spaced not more than 4 feet apart, set not less than 3 feet deep in concrete footing, with top posts not less than 3 feet above the ground, and located 3 feet or more away from the ESS
- c) Protected by wheel barriers anchored in place located 4.5 feet or more away from the ESS or
- d) Protected by other barriers where approved

- **10** ESS installed on the rooftop is:
 - a) Located at least 5 feet away from the edge of the roof if the height of the system is 5 feet or less
 - b) Located at least the height of the system away from the edge of the roof if the height of the

- system is greater than 5 feet
- c) Located within 10 feet of the fire service access point
- d) Accessible via a stairway through a bulkhead from the building interior or exterior stairway

- **11** Rooftops with an ESS must have:
 - a) Service walkways at least 5 feet in width from the access point to the ESS
 - b) Roofing materials under and within 5 feet of the ESS that are noncombustible or have a Class A ASTM E108 or UL790 rating
 - c) A Class I standpipe outlet installed on the roof level of the building or in the stairway bulkhead at the top level
 - d) An approved radiant energy-sensing fire detection system



PHOTOVOLTAIC AND ENERGY STORAGE SYSTEM INTERCONNECTION REQUIREMENTS

- **12** The inverter installation meets the requirements of one of the items below:
 - a) Supply-side connection complies with power source continuous output rating, conductor size, over current protection, connection, and ground fault requirements in NEC 705.11
 - b) Load-side connection complies with 705.12 and can meet the 120% panel board busbar rating allowance in a building or the PV supplies and loads do not exceed the busbar rating

- c) Load-side Power Control Systems which use controls to prevent overcurrent of equipment are listed to UL1741 CRD and comply with monitoring, setting, overcurrent protection, single power source ratings, and access requirements in NEC 705.13
- d) Load-side distribution equipment listed to combine sources and supply loads



PV SYSTEM ELECTRICAL CODE INSTALLATION REQUIREMENTS

- **13** Major electrical components including PV modules, DC-to-DC converters, and inverters, are identified for use in PV systems.
- **14** Inverters are listed as utility-interactive in accordance with UL 1741.
- **15** PV Modules are listed as UL 1703, UL 61730-1, or UL 61730-2.
- **16** PV panel systems and array mounting systems are listed and identified with a fire classification in accordance with UL 2703.
- **17** The PV array consists of no more than 2 series strings per inverter input and no more than 4 source circuit strings in total per inverter.
- **18** The maximum PV DC system voltage for a single-family home or duplex is limited to 1000Vdc. Use either the checklist shown the general installation

guide or methods described in 690.7(A)(1) or 690.7(A)(3) to ensure the system is designed and connected so that 1000Vdc is not exceeded on the average coldest day of the year.

- **19** PV system circuits on buildings meet requirements for controlled conductors.
 - a) Controlled conductors more than one foot from the array are capable of being shutdown to below 30 volts within 30 seconds
 - b) PV array wiring within the array is either listed to the PV Hazard Control product safety standard (UL3741) or limited to not more than 80 volts within 30 seconds of rapid shutdown initiation
- **20** The PV System disconnecting means is sized for the maximum short circuit current and voltage and installed in a readily accessible location.



STRUCTURAL PV ARRAY MOUNTING AND INSTALLATION LOCATION REQUIREMENTS

- **21** PV arrays are located to meet the fire setback and access pathway requirements unless determined by the fire code official that the roof configuration is similar to that of a Group R-3 occupancy:
 - a) There is a 4-foot wide clear perimeter around the edges of the roof for building sides less than 250 feet. For building sides equal to or larger than 250 feet, 6-foot wide clear perimeter pathways are required.
 - b) Interior pathways is provided at intervals not greater than 150 feet throughout the length and width of the roof.
 - c) A pathway at least 4 feet wide is provided in a straight line to roof standpipes or ventilation hatches.
 - d) A pathway at least 4 feet wide is provided around roof access hatches, with at least one pathway to a parapet or roof edge.
- **22** PV array determined by a fire code official that the roof configuration is similar to that of a Group R-3 occupancy must meet the following IRC fire setback and access pathway requirements.
 - a) At least two pathways not less than 3 feet wide are provided on separate roof planes from the lowest roof edge to the ridge.
 - b) At least one pathway is on the street or driveway side of the roof.
 - c) PV arrays occupying less than 1/3 of the roof area are set back 1.5 feet on both sides of the horizontal ridge. PV arrays occupying more than 1/3 of the roof area have a 3 foot setback on both sides of a horizontal ridge. (IRC 324.6)
- **23** Roof structures are designed to resist the applicable uniform concentrated roof live loads with PV panel dead loads and with PV panels present. Roof live loads do not need to be applied if the space between the panels and the roof surface is 2 feet or less.
- **24** The roof structure are designed to accommodate PV panels or modules and ballast dead load, including concentrated loads from support frames, roof live loads, snow drift loads created by PV panels and modules if applicable, and other applicable loads.

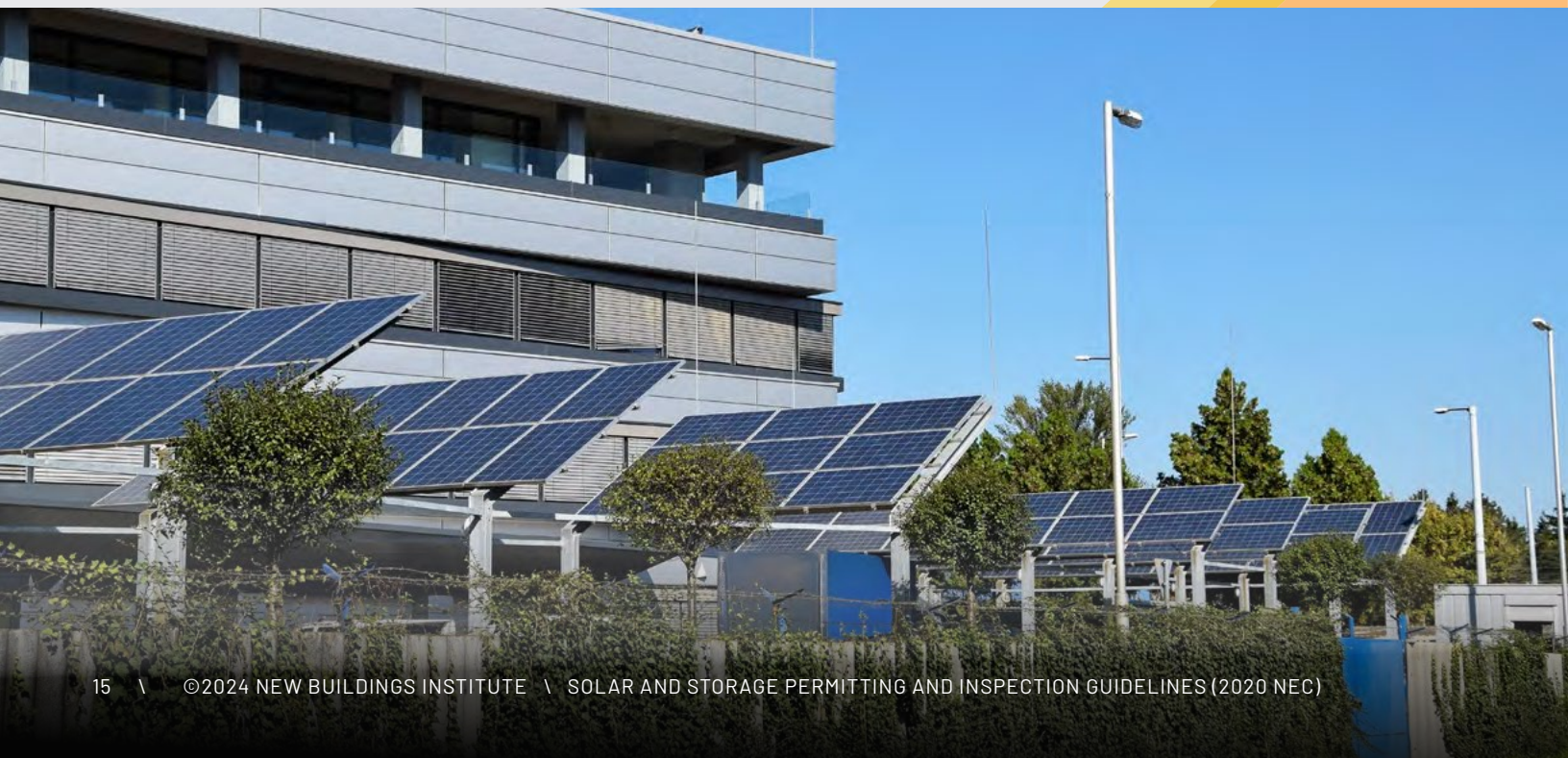



FIELD INSPECTION CHECKLIST



HELPFUL TIP

Numbers that correspond to the requirement in the permitting checklist are provided next to the same requirement in the field inspection checklist.



ENERGY STORAGE SYSTEM REQUIREMENTS

Make sure all ESS disconnects and circuit breakers are in the open position and verify the following:

- 1** All work done in a neat and workmanlike manner (NEC 110.12).
- 2** Equipment installed, listed, and labeled according to the approved plan and manufacturers' instructions (e.g., ESS units, battery units, inverters, disconnects). (1-3)
- 3** ESS equipment model numbers, quantity, and location according to the approved plan. (see PV+ESS general installation guideline for additional information)
 - a) ESS units have either 3-foot spacing between units or ESS unit is UL9540a listed and manufacturer spacing requirements are followed. (4-7)
- 4** Access and working space for ESS equipment such as ESS units, battery units, inverters, disconnecting means, and panelboards is adequate. Working space is at least 30 inches in width, 6.5 feet in height and 4 feet in depth or the width, height and depth of the equipment, whichever is greater.
- 5** For ESS installed on exterior walls: (8)
 - a) ESS is separated from doors, operable openings or HVAC inlets by 5 feet.
 - b) ESS is located 10 feet away (or 3 feet away or enclosed in a weatherproof enclosure of noncombustible material) from combustible vegetation, egress under fire conditions, other buildings, lot lines public ways, stored combustible or hazardous materials, and parking spaces.
- 6** For ESS installed in indoor areas, fire barrier, smoke detection, and fire suppression systems are installed. (9)
- 7** For ESS installed in a parking garage: (10)
 - a) ESS has an approved radiant energy sensing fire detection system,
 - b) ESS is installed within a locked gate, fence or other barrier that prevents the public from standing within 5 feet of the ESS, and
 - c) ESS is either installed in a location not subject to vehicular impact or protected from vehicle impact with guard posts, wheel barriers or other approved barrier.
- 8** For ESS installed on the rooftop, ESS is located at least 5 feet away from the edge of the roof in a location that is accessible via stairway from the building interior or exterior stairway and a 5 feet wide service walkway. (11)
- 9** PV system electrical interconnection point (supply-side or load-side connection, load-side power control systems, and load-side distribution equipment) complies with approved plan.
- 10** Grounding/bonding of ESS units, battery units, inverters, conduit and other electrical equipment according to the NEC and manufacturer's instructions.
- 11** Conduit and other wiring methods installation according to the NEC and the approved plan. (13)
- 12** Conductors, cables, and conduit types, sizes, and markings according to the approved plan. (13)
- 13** Overcurrent devices are the type and size according to the approved plan. (13)
- 14** Disconnects according to the approved plan and properly located as required by the NEC. (13)
- 15** PV system electrical interconnection point (supply-side or load-side connection, load-side power control systems, and load-side distribution equipment) complies with approved plan. (13)



PHOTOVOLTAIC ELECTRICAL AND STRUCTURAL REQUIREMENTS

Make sure all PV disconnects and circuit breakers are in the open position and verify the following:

- 16** All work done in a neat and workmanlike manner.
- 17** PV module model number, quantity, and location according to the approved plan.
- 18** Array mounting system and structural connections according to the approved plan and manufacturers' instructions. (17)
- 19** Roof penetrations flashed/sealed according to the approved plan and manufacturers' instructions.
- 20** Exposed cables are properly secured, supported, and routed to prevent physical damage.
- 21** Conduit installation according to NEC 690.31 and the approved plan. (19)
- 22** Firefighter access according to IFC 1205.3.1-2 and the approved plan. (23)
- 23** Roof-mounted PV mounting systems and modules have sufficient fire classification. (17)
- 24** Grounding/bonding of rack, modules, inverter(s), and other electrical equipment according to the manufacturer's instructions.
- 25** Equipment installed, listed, and labeled according to the approved plan and manufacturers' instructions (e.g., PV modules, inverters, dc-to-dc converters, rapid shutdown equipment). (12-14)
- 26** For grid-connected systems, inverter is marked "interactive," or documentation is provided to show that inverter meets utility interconnection requirements. (13)
- 27** Conductors, cables, and conduit types, sizes, and markings according to the approved plan. (18, 19, 21)
- 28** Overcurrent devices are the type and size according to the approved plan.
- 29** Disconnects according to the approved plan and properly located as required by the NEC. (22)
- 30** PV system electrical interconnection point (supply-side or load-side connection, loadside power control systems, and load-side distribution equipment) complies with approved plan. (13)
- 31** PV system markings, labels, and signs according to the approved plan.
- 32** PV system equipment grounding conductors installed according to the approved plan.
- 33** Access and working space is provided for PV equipment such as inverters, disconnecting means, and panelboards (not required for PV modules).
- 34** The rapid shutdown system is installed and operational according to the approved plan and manufacturers' instructions. (19)



SUPPORTING RESOURCES

International Code Council "2021 International Fire Code", Oct. 2020,
<https://codes.iccsafe.org/content/IFC2021P1>

International Code Council "2021 International Residential Code", Dec. 2020,
<https://codes.iccsafe.org/content/IRC2021P1>

National Fire Protection Association. "NFPA 70®." NFPA 70®: National Electrical Code®, Delmar Cengage Learning, 18 Sept. 2019, <https://www.nfpa.org/codes-and-standards/all-codes-and-standards/list-of-codes-and-standards/detail?code=70&access=open>

"National Simplified Residential PV and Energy Storage Permit Guidelines." SolSmart, <https://solsmart.org/resources/national-simplified-residential-pv-and-energy-storage-permit-guidelines/>



APPENDIX A: SOLAR AND/OR ESS PERMIT APPLICATION

FOR OFFICE USE ONLY

Application Number: _____

Permit Number: _____

Issued By: _____

Date Applied: _____

Date Issued: _____

SECTION 1 - GENERAL INFO

PROJECT ADDRESS _____

PROPERTY OWNER'S NAME _____

PHONE NUMBER _____

EMAIL _____

PROPERTY OWNER'S MAILING ADDRESS (IF DIFFERENT FROM PROJECT ADDRESS) _____

SECTION 2 - PROJECT DETAILS

BUILDING TYPE/EXISTING USE

SINGLE FAMILY

DUPLEX

MULTI-FAMILY

COMMERCIAL / INDUSTRIAL

NEW CONSTRUCTION

OTHER: _____

NEW OR EXISTING PV SYSTEM

NEW SYSTEM

ADDITIONAL SYSTEM

SYSTEM REPLACEMENT

PV SYSTEM TYPE

ROOF MOUNTS

GROUND MOUNTS

BUILDING INTEGRATED/ OTHER

INVERTER CONFIGURATION

STRING INVERTER

STRING INVERTER W/ DC CONVERTERS

MICROINVERTERS OR AC MODULES

TOTAL PV SYSTEM SIZE _____ kW DC

TOTAL SQ. FT. OF PV SYSTEM _____ SQ FT

PROJECT VALUATION \$ _____

INCLUDES ENERGY STORAGE SYSTEM YES NO

TOTAL SYSTEM CAPACITY RATING _____ kWh

POWER RATING _____ kW

AC DC

PROJECT DESCRIPTION:

SECTION 3 - CONTRACTOR INFORMATION

CONTRACTOR BUSINESS NAME	CONTRACTOR LICENSE NUMBER	
--------------------------	---------------------------	--

BUSINESS ADDRESS		
------------------	--	--

CONTRACTOR CONTACT NAME	PHONE NUMBER	EMAIL
-------------------------	--------------	-------

SECTION 4 - PERMIT FEE

Submit permit fee according to building department instructions.

SECTION 5 - IMPORTANT NOTICE

A permit must be obtained for all installations or alterations of electrical equipment BEFORE WORK STARTS. Refer to the EVSE Permitting Checklist for additional documents required. Failure to provide all required documents, including **(1) Site Plan, (2) Electrical Diagram, and (3) Specification Sheets and Installation Manuals** will delay permit approval. All permits expire six (6) months after the date of issuance. Failure to start the work authorized by a permit within this six-month period renders the permit invalid and a new permit must be obtained. Once work begins, noticeable progress must continue until completion. All work must be complete within eighteen (18) months of a permit issue date.

Please Submit the following additional documents with the EVSE Permit Application:

- Site Plan
- Electrical Diagram
- EVSE Specification Sheets and Installation Manuals
- Transformer Specification Sheets
- Load Calculation
- Automatic Load Management System
- Specification Sheet if applicable

Submit Permit Application

Submit permit application according to building department instructions.

SECTION 6 - APPLICANT SIGNATURE

I, the undersigned, certify that I have proper authority to apply for this permit, that the Contractor has obtained a signed contract from the Property Owner for the specified work, that all contractors have consented to being listed, and that all the information contained on this application is true and accurate to the best of my knowledge.

NAME	TITLE
------	-------

SIGNATURE	DATE
-----------	------

APPENDIX B: SOLAR AND ENERGY STORAGE STANDARD ELECTRICAL LINE DIAGRAMS

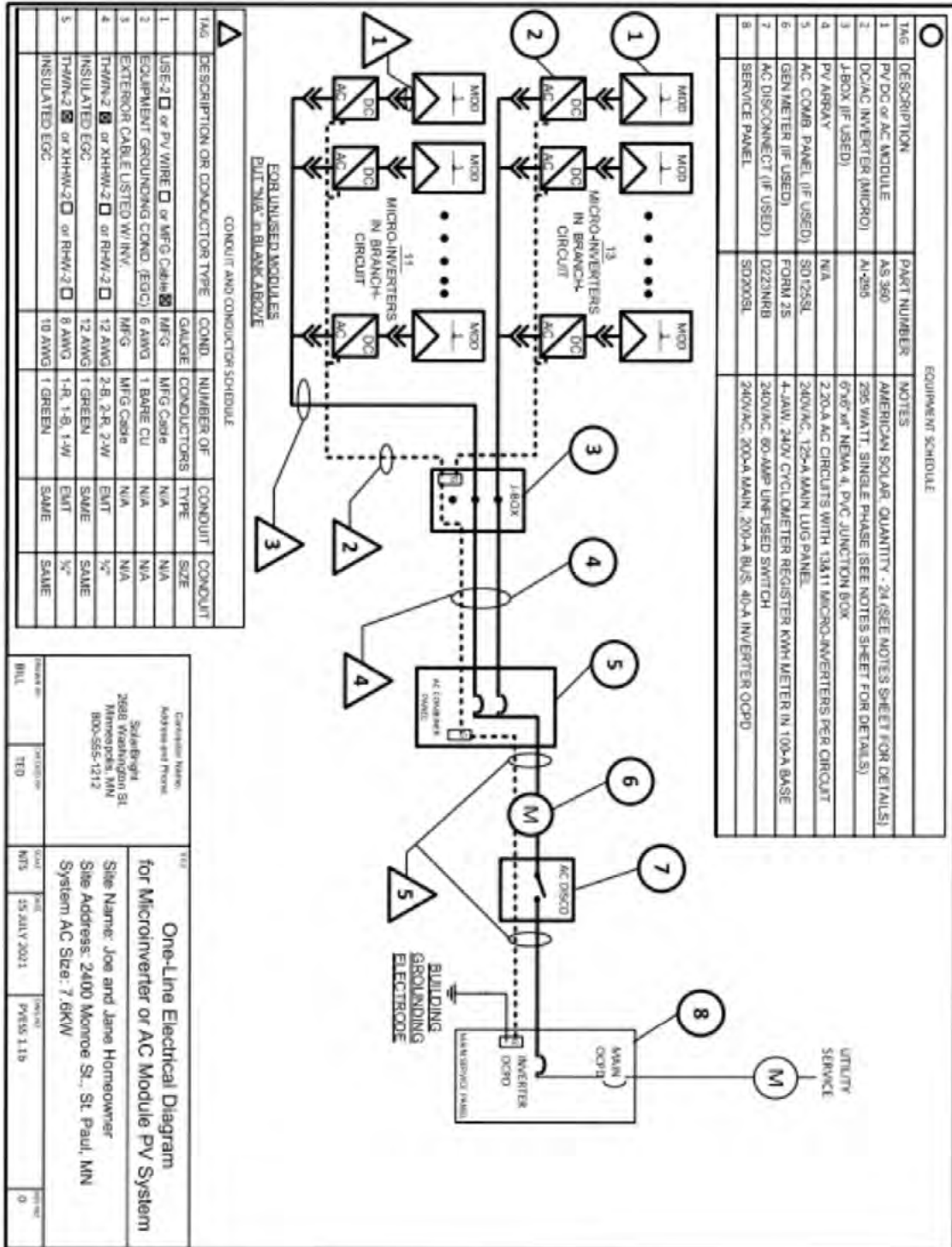

FIGURE 9: ONE LINE PV ONLY WITH MICROINVERTERS

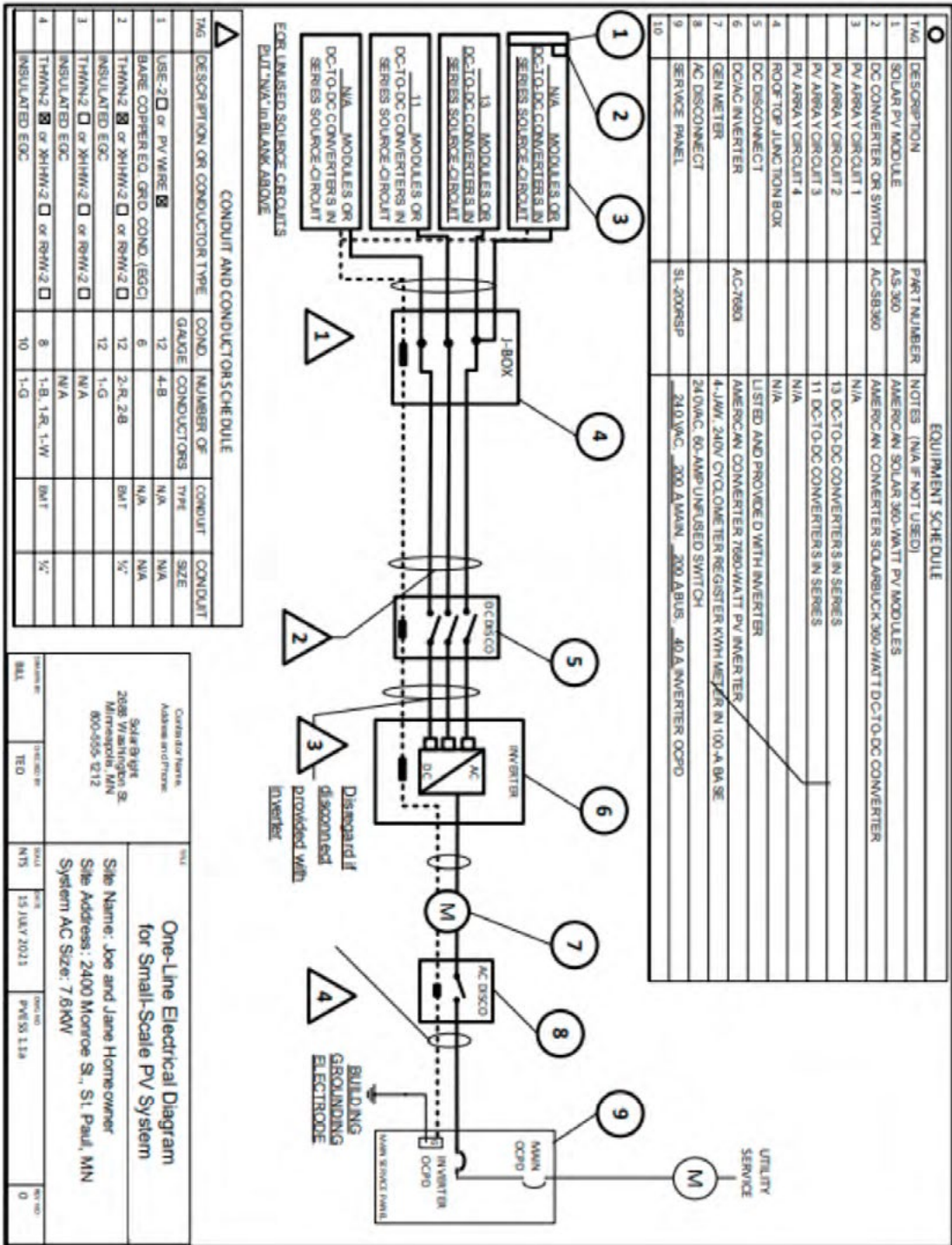

FIGURE 10: ONE LINE PV ONLY WITH DC CONVERTERS

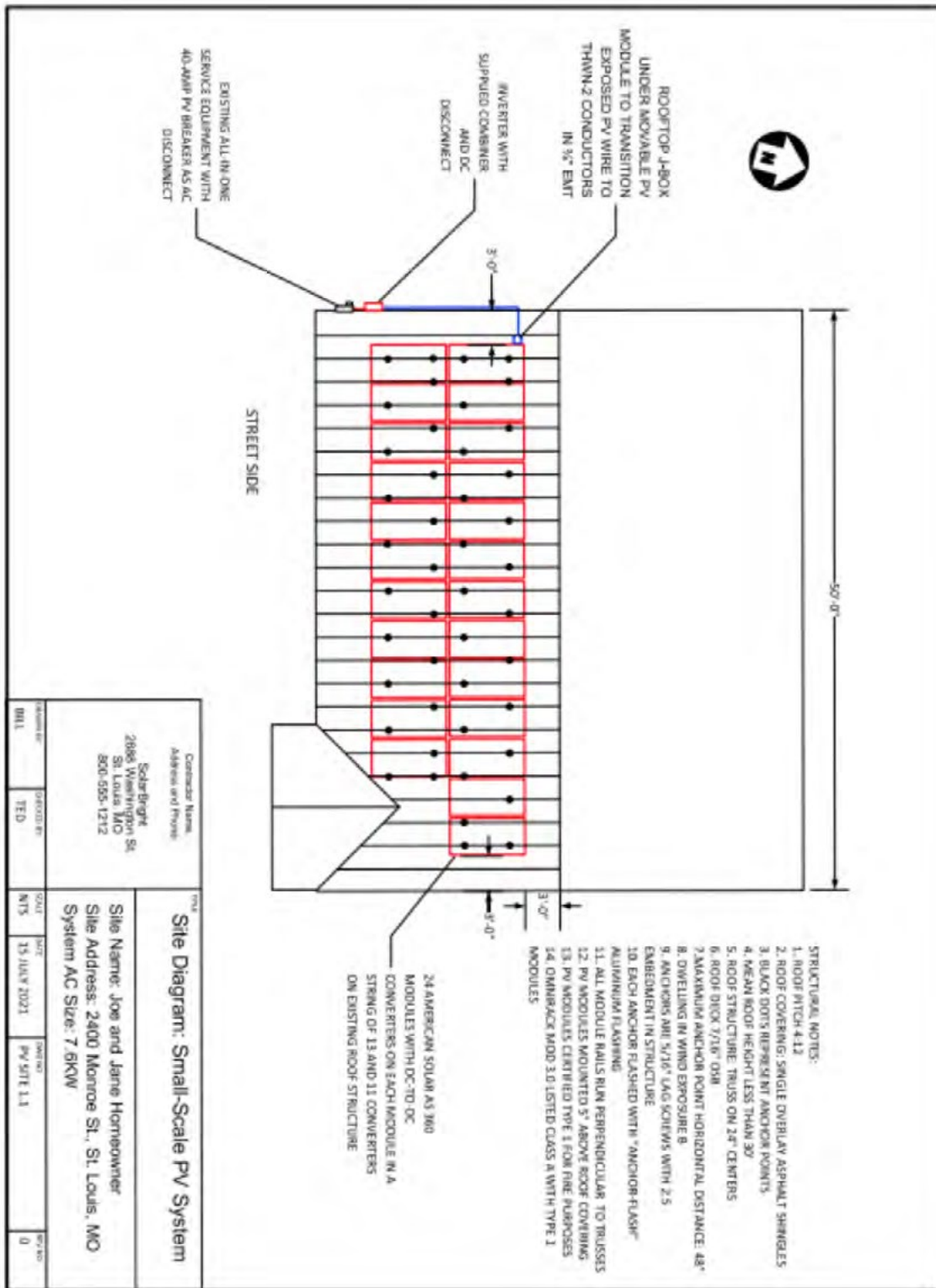

FIGURE 11: SITE DIAGRAM PV ONLY WITH DC CONVERTERS

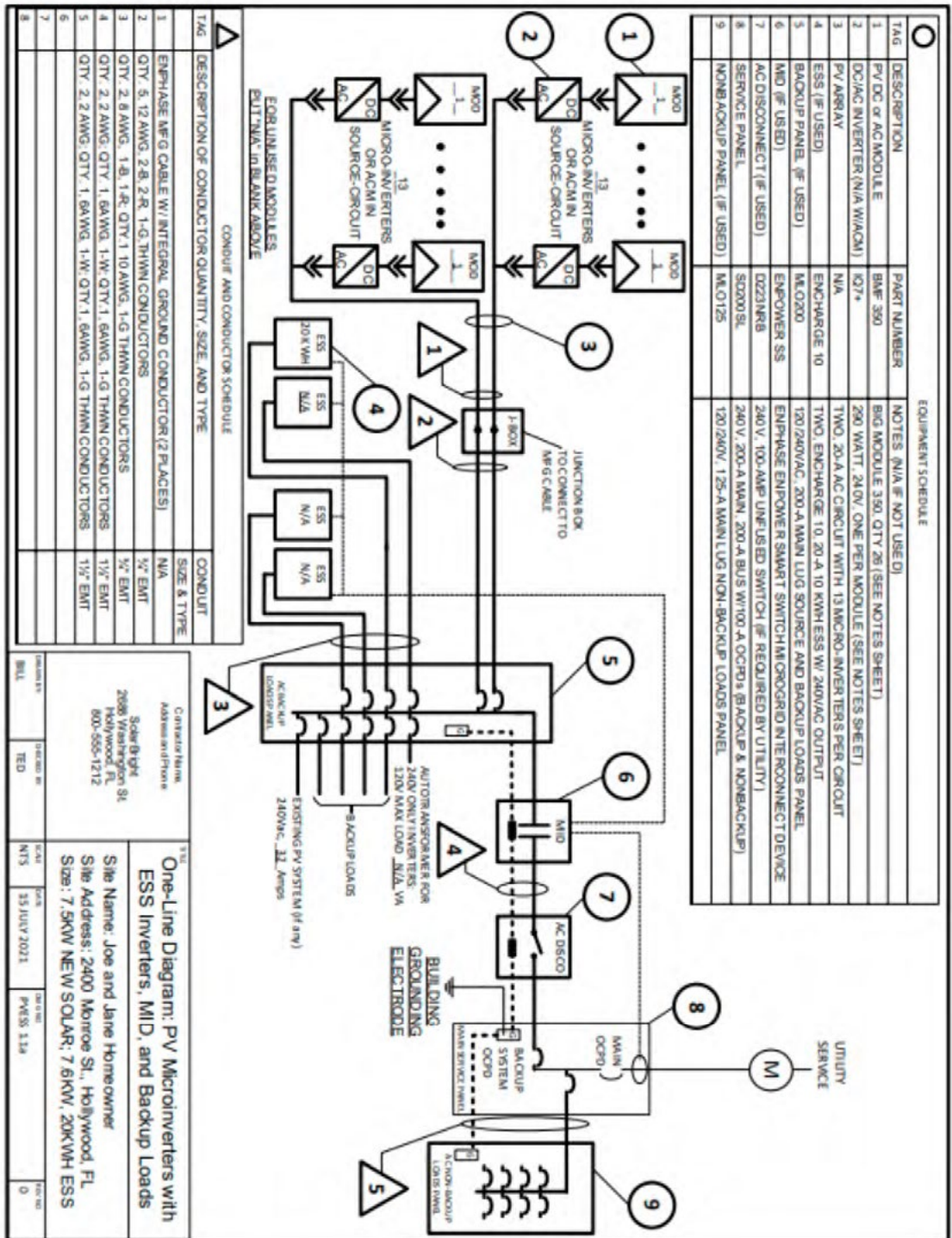

FIGURE 12: ONE-LINE PV AND ESS WITH MICROINVERTERS AND MID

PV MODULE RATINGS @ STC	
MODULE MAKE	AMERICAN SOLAR
MODULE MODEL	AS-360
MAX POWER-POINT CURRENT (I _{mp})	9.1 A
MAX POWER-POINT VOLTAGE (V _{mp})	39.4 V
OPEN-CIRCUIT VOLTAGE (V _{oc})	47.4 V
SHORT-CIRCUIT CURRENT (I _{sc})	9.7 A
MAX SERIES FUSE (I _{OPD})	25 A
MAXIMUM POWER (P _{max})	360 W
MAX VOLTAGE (TYP 600V _{oc})	1000 V
VOC TEMP COEFF (mV/°C or %/°C)	-0.28

NOTES FOR ALL DRAWINGS:	
OOPD = OVERCURRENT PROTECTIVE DEVICE NATIONAL ELECTRICAL CODE® REFERENCES SHOWN AS (NEC XXX.XX)	

DC-TO-DC CONVERTER RATINGS (if used)	
CONVERTER MAKE	
CONVERTER MODEL	
MAX CURRENT	
MAX VOLTAGE	
MAXIMUM POWER	
MAX OUTPUT CURRENT (TYP 600V _{oc})	

INVERTER RATINGS	
INVERTER MAKE	AMERICAN CONVERTER
INVERTER MODEL	AC-295I
MAX DC VOLT RATING	80 V
MAX POWER @ 40°C	295 W
NOMINAL AC VOLTAGE	240 V
MAX AC CURRENT	1.23 A
MAX OCPD RATING	20 A

*SIGN FOR PV DC DISCONNECT (if used)	
PHOTOVOLTAGE POWER SOURCE	
MAX VOLTAGE	V
MAX CIRCUIT CURRENT	A
MAX OUTPUT CURRENT	A

WARNING: ELECTRICAL SHOCK HAZARD—LINE AND LOAD MAY BE ENERGIZED IN OPEN POSITION

*SIGN FOR PV SYSTEM DISCONNECT (if used)	
PV SYSTEM DISCONNECT	
AC OUTPUT CURRENT	32 A
NOMINAL AC VOLTAGE	240 V

*SIGN FOR ESS DISCONNECT (if used)	
ESS DISCONNECT	
ESS VOLTAGE (AC OR DC)	240 VAC

*NOTE: MICROINVERTER, LAND AC, MODULE SYSTEMS DO NOT NEED DC DISCONNECT SIGN SINCE MARKING ON PV/MODULE COVERS NEED INFORMATION

*SIGN FOR PV DC DISCONNECT (if used)	
PHOTOVOLTAGE POWER SOURCE	
MAX VOLTAGE	V
MAX CIRCUIT CURRENT	A
MAX OUTPUT CURRENT	A

WARNING: ELECTRICAL SHOCK HAZARD—LINE AND LOAD MAY BE ENERGIZED IN OPEN POSITION

*SIGN FOR PV SYSTEM DISCONNECT (if used)	
PV SYSTEM DISCONNECT	
AC OUTPUT CURRENT	32 A
NOMINAL AC VOLTAGE	240 V

*SIGN FOR ESS DISCONNECT (if used)	
ESS DISCONNECT	
ESS VOLTAGE (AC OR DC)	240 VAC

*NOTE: MICROINVERTER, TERLAND AC, MODULE SYSTEMS DO NOT NEED DC DISCONNECT SIGN SINCE MARKING ON PV/MODULE COVERS NEED INFORMATION

SOLAR PV SYSTEM EQUIPPED WITH RAPID SHUTDOWN

TERLAND SHUTDOWN SYSTEM PROVIDES "SAFE" POSITION TO SHUTDOWN PV SYSTEM AND REDUCE SHOCK HAZARD IN ARRAY



1) IF UTILITY REQUIRES A VISIBL E-BREAK SWITCH, DOES THIS SWITCH MEET THE REQUIREMENT? YES NO N/A

2) IF GENERATION METER REQUIRED, DOES THIS METER SOCKET MEET THE REQUIREMENT? YES NO N/A

3) SIZE INVERTER OUTPUT CIRCUIT (AC) CONDUCTORS ACCORDING TO INVERTER OCPD AMPERE RATING. (See Table 705.12)

4) DOES TOTAL SUPPLY BREAKERS COMPLY WITH

- 120% BUSBAR RULE IN 705.12(B)(2017 NEC)
- SUM OF BRANCH BREAKERS
- POWER CONTROL SYSTEMS
- LISTED EQUIPMENT FOR COMBINING SOURCES

NOTES FOR INVERTER CIRCUITS

THIS PANEL, FED BY MULTIPLE SOURCES (UTILITY AND SOLAR)

WARNING: INVERTER OUTPUT CONNECTION: DO NOT RELOCATE THIS OVERCURRENT DEVICE.

THIS PANEL, FED BY MULTIPLE SOURCES (UTILITY AND SOLAR)

WARNING: TOTAL RATING OF ALL OVERCURRENT DEVICES EXCLUDING MAIN SUPPLY OVERCURRENT DEVICE SHALL NOT EXCEED CAPACITY OF BUSBAR

Contractor Name, Address and Phone:	2688 Washington St Cary, NC 800-555-1212
Contractor Name, Address and Phone:	2400 Monroe St., Raleigh, NC 7.6kW, 20kWh ESS
Contractor Name, Address and Phone:	2400 Monroe St., Raleigh, NC 7.6kW, 20kWh ESS
Contractor Name, Address and Phone:	2400 Monroe St., Raleigh, NC 7.6kW, 20kWh ESS

Notes for One-Line Diagram for PV and Energy Storage Systems

Site Name: Joe and Jane Homeowner
Site Address: 2400 Monroe St., Raleigh, NC
Size: 7.6kW NEW SOLAR; 7.6kW, 20kWh ESS

DATE	15 JULY 2021	PROJECT	PV/ESS 1.2A	REVISED	0
------	--------------	---------	-------------	---------	---

FIGURE 13: NOTES FOR ONE-LINE PV AND ESS WITH MICROINVERTERS AND MID

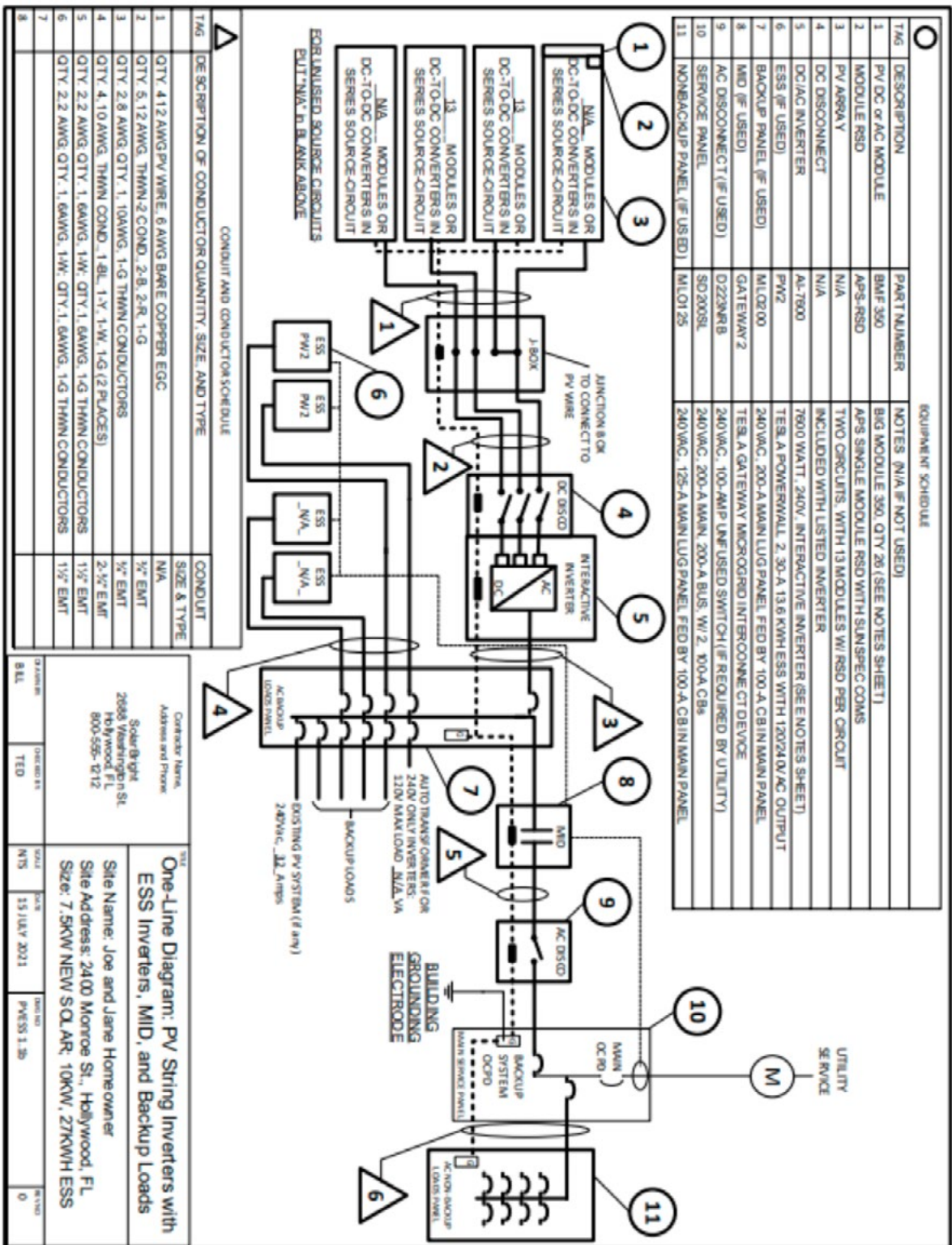

FIGURE 14: ONE-LINE PV AND ESS WITH STRING INVERTERS AND MID

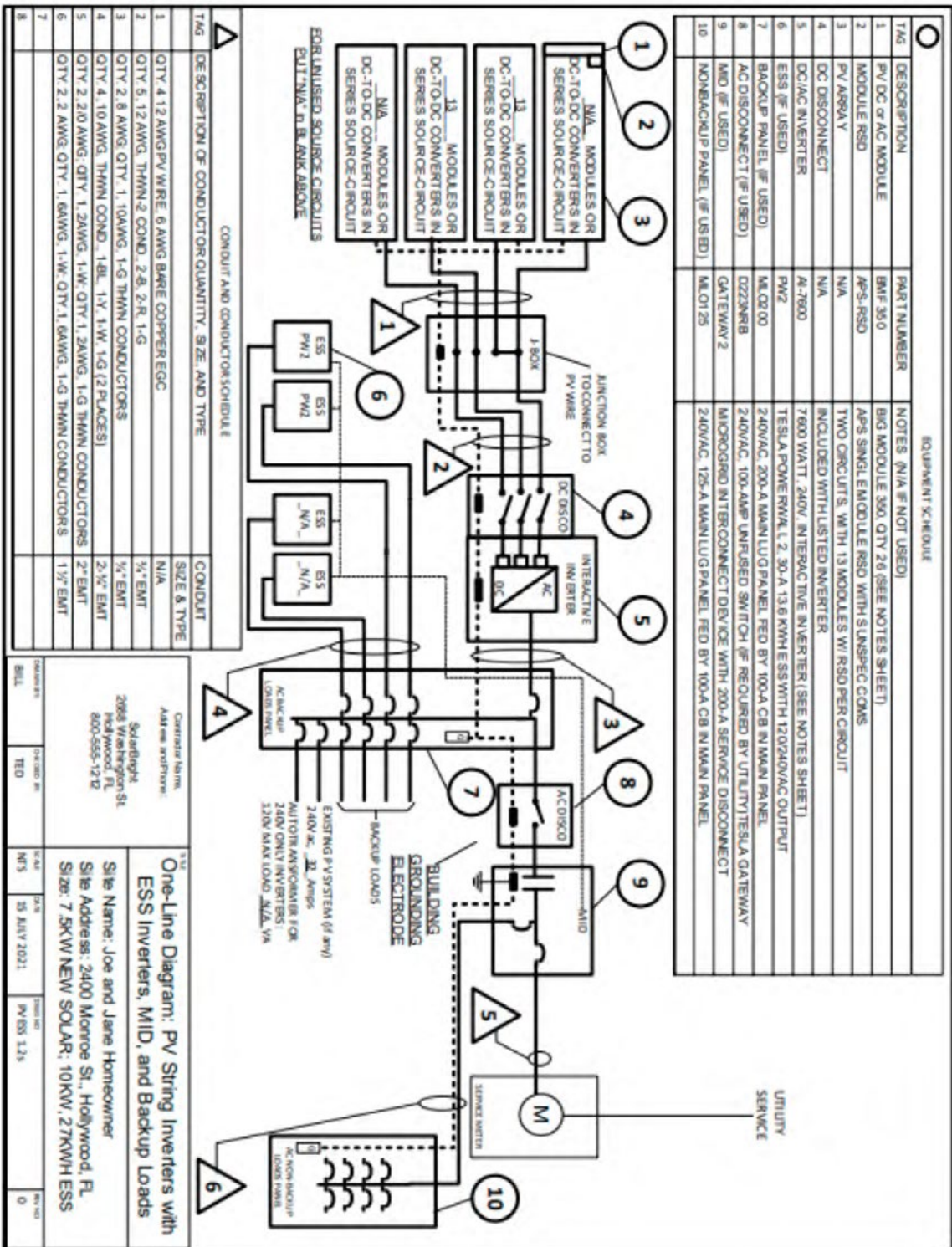

FIGURE 15: ONE-LINE PV AND ESS WITH STRING INVERTER AND MID WITH SERVICE DISCONNECT

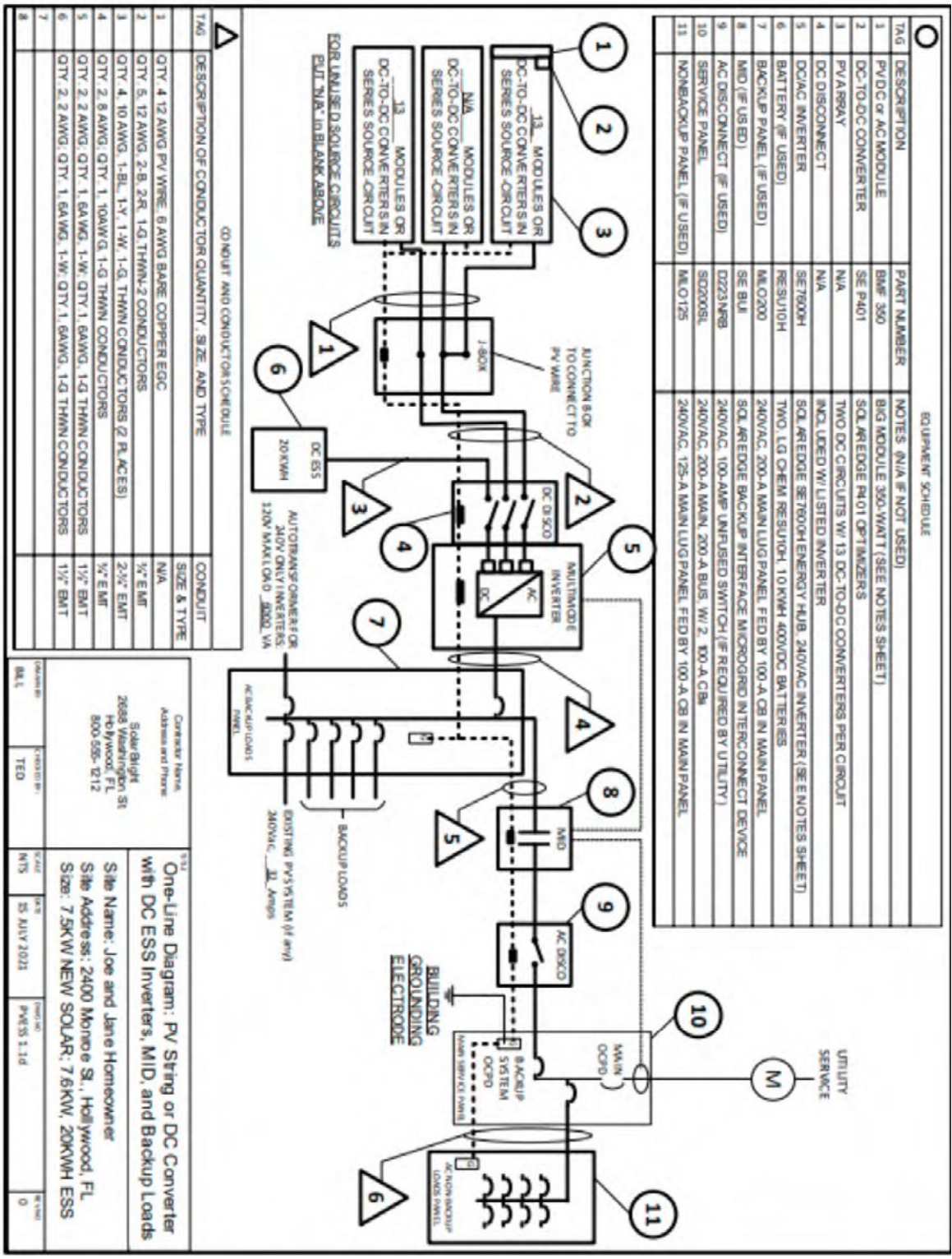

FIGURE 16: ONE-LINE PV AND ESS WITH STRING INVERTER AND DC CONVERTERS AND MID

PV MODULE RATINGS @ STC	
MODULE MAKE	AMERICAN SOLAR
MODULE MODEL	AS-360
MAX POWER-POINT CURRENT (I _{mp})	9.1 A
MAX POWER-POINT VOLTAGE (V _{mp})	39.4 V
OPEN-CIRCUIT VOLTAGE (V _{oc})	47.4 V
SHORT-CIRCUIT CURRENT (I _{sc})	9.7 A
MAX SERIES FUSE (OCPD)	25 A
MAXIMUM POWER (P _{max})	360 W
MAX VOLTAGE (TYP 600V _{dc})	1000 V
VOC TEMP COEFF (mV/°C or %/°C)	-0.28

NOTES FOR ALL DRAWINGS:	
OCPD = OVERCURRENT PROTECTIVE DEVICE	
NATIONAL ELECTRICAL CODE® REFERENCES SHOWN AS (NEC XXXXX)	

DC-TO-DC CONVERTER RATINGS (if used)	
CONVERTER MAKE	AMERICAN CONVERTER
CONVERTER MODEL	AC-360
MAX CURRENT	12 A
MAX VOLTAGE	80 V
MAXIMUM POWER	360 W
MAX OUTPUT CIRCUIT V (TYP 600V _{dc})	600 V

INVERTER RATINGS	
INVERTER MAKE	AMERICAN CONVERTER
INVERTER MODEL	AC-7901
MAX DC VOLT RATING	80 V
MAX POWER @ 40°C	790 W
NOMINAL AC VOLTAGE	240 V
MAX AC CURRENT	32 A
MAX OCPD RATING	40 A

*SIGN FOR PV DC DISCONNECT (if used)	
PHOTOVOLTAC POWER SOURCE	
MAX VOLTAGE	575 V
MAX CIRCUIT CURRENT	15 A
MAX OUTPUT CURRENT	12 A

WARNING: ELECTRICAL SHOCK HAZARD—LINE AND LOAD MAY BE ENERGIZED IN OPEN POSITION

*SIGN FOR PV SYSTEM DISCONNECT (if used)	
PV SYSTEM DISCONNECT	
AC OUTPUT CURRENT	32 A
NOMINAL AC VOLTAGE	240 V

*SIGN FOR ESS DISCONNECT (if used)	
ESS DISCONNECT	
ESS VOLTAGE (AC OR DC)	240 V AC

*NOTE: MICROINVERTER AND AC MODULE SYSTEMS DO NOT NEED DC DISCONNECT SIGN SINCE MARKING ON PV MODULE COVERS NEEDED INFORMATION

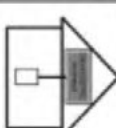
*SIGN FOR NEC 690.12 (if used -if added system)	
SOLAR PV SYSTEM EQUIPPED WITH RAPID SHUTDOWN	
TURN RAPID SHUTDOWN OFF POSITION TO SHUTDOWN PV SYSTEM AND REDUCE SHOCK HAZARD IN PANEL	

NOTES FOR INVERTER CIRCUITS

- IF UTILITY REQUIRES A VISUAL BREAK SWITCH, DOES THIS SWITCH MEET THE REQUIREMENT? YES NO N/A
- IF GENERATION METER REQUIRED, DOES THIS METER SOCKET MEET THE REQUIREMENT? YES NO N/A
- SIZE INVERTER OUTPUT CIRCUIT (AC) CONDUCTORS ACCORDING TO INVERTER OCPD AMPERE RATING. (See Table 705.12)
- DOES TOTAL SUPPLY BREAKERS COMPLY WITH:
 - 100% SUBBAR RULE IN 705.12(B)(2017 NEC)
 - SUM OF BRANCH BREAKERS
 - POWER CONTROL SYSTEMS
 - LISTED EQUIPMENT FOR COMBINING SOURCES

NOTES FOR DISTRIBUTION PANELS

THIS PANEL FED BY MULTIPLE SOURCES (UTILITY AND SOLAR)

SIGN FOR 120% OVERTON (if used)

WARNING: INVERTER OUTPUT CONNECTION: DO NOT RELOCATE THIS OVERCURRENT DEVICE

NOTES FOR SUM OF BREAKERS OPTION (if used)

WARNING: TOTAL RATING OF ALL OVERCURRENT DEVICES EXCLUDING MAIN SUPPLY OVERCURRENT DEVICE SHALL NOT EXCEED CAPACITY OF BUSBAR.

Contract Name Address and Phone 2088 Washington St Cary, NC 800-555-1212	DATE BY BILL	DATE BY TED	DATE BY NTS	DATE BY 15 JULY 2021	PROJECT PV/ESS 12A	REV 0
--	-----------------	----------------	----------------	-------------------------	-----------------------	----------

*12

Notes for One-Line Diagram for PV and Energy Storage Systems

Site Name: Joe and Jane Homeowner
Site Address: 2400 Monroe St., Raleigh, NC
Size: 7.1kW NEW SOLAR, 7.6kW, 20KWH ESS

FIGURE 17: NOTES FOR ON-LINE PV AND ESS WITH STRING INVERTERS WITH DC CONVERTERS AND MID

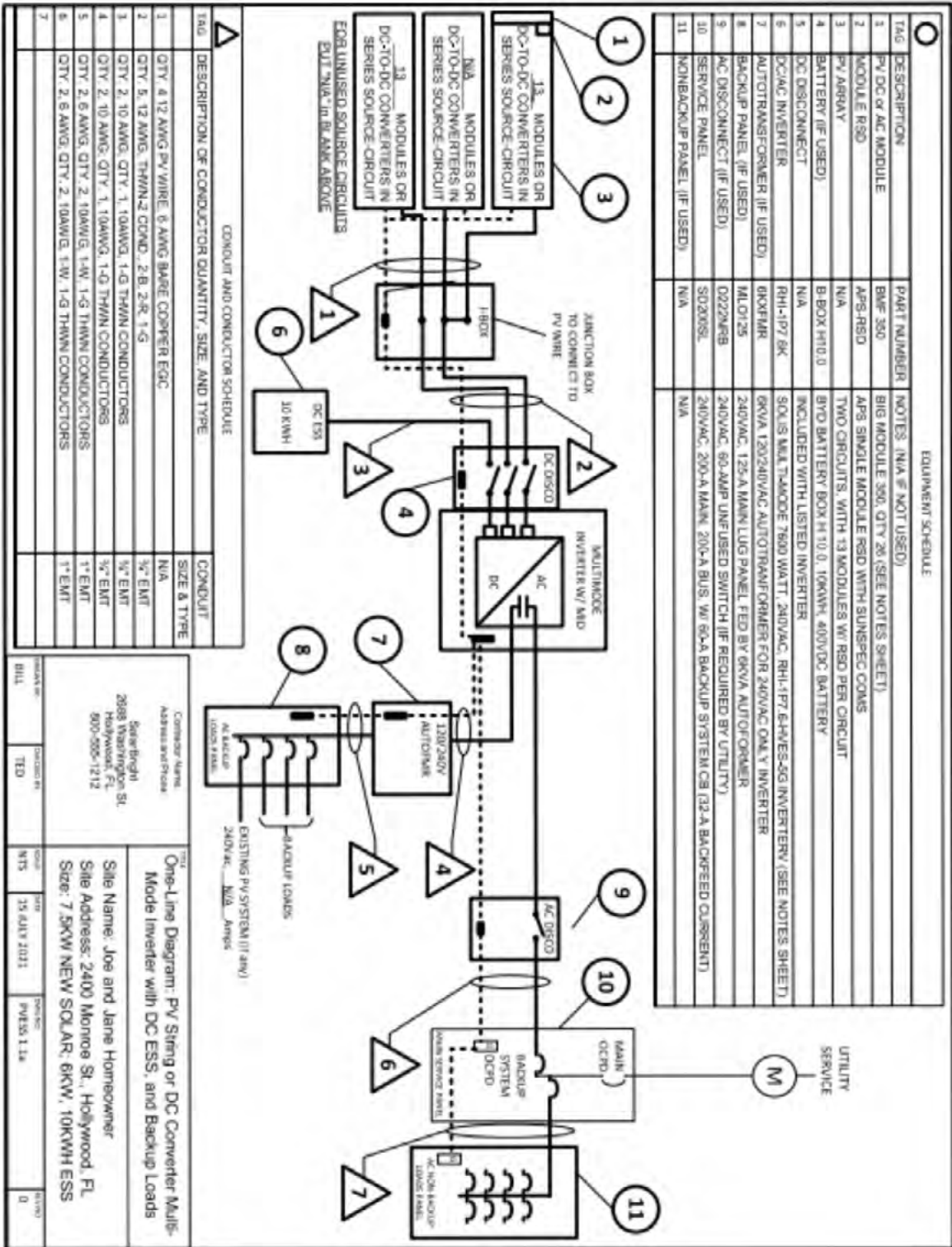

FIGURE 18: ONE-LINE PV AND ESS WITH MULTI-MODE INVERTER



Earth Advantage® is a 501(c)(3) nonprofit focused on helping to create an informed and humane residential real estate marketplace that: acknowledges both the climate impacts of housing and the impact climate has on housing; provides all homebuyers and renters with access to sustainability-related information about a home; supports equitable housing outcomes, protecting those most vulnerable from the effects of climate change, and; recognizes both the personal and societal value that climate-friendly housing creates. Visit earthadvantage.org to learn more.



New Buildings Institute (NBI) is a nonprofit organization working to advance energy efficiency and decarbonization of the built environment. Our efforts are imperative to keeping energy costs affordable, cutting carbon emissions that are fueling climate change, and delivering on improved health, safety, and resiliency for all. We work collaboratively with industry market players—governments, utilities, advocates, AEC professionals, and others—to drive leading-edge design, innovative technologies, and public policies and programs for scale. Throughout its 25-year history, NBI has become a trusted and independent resource helping to create buildings that are better for people, communities, and the planet. Visit newbuildings.org to learn more.

Electric Vehicle Supply Equipment (EVSE) Permitting & Inspection Guidelines is made available under a Creative Commons Attribution 4.0.